

Uniden®

BCD996P2

Owner's Manual



©2015 Uniden America Corporation

Printed in Vietnam
U01UB378ZZZ (0)

© 2015 Uniden America Corporation, Irving, Texas.
Questions? Problems? Get help on the web at www.uniden.com.
Or call our Customer Service line at 800-620-7531.

CONTENTS

IMPORTANT INFORMATION	3
THE FCC WANTS YOU TO KNOW	3
MODIFICATION NOTICE	3
PART 15 INFORMATION	3
SCANNING LEGALLY.....	3
AVIS D'INDUSTRIE CANADA	4
MAIN FEATURES	5
SCANNING CONCEPTS	7
UNDERSTANDING DYNAMIC MEMORY.....	7
UNDERSTANDING QUICK KEYS	8
UNDERSTANDING CONVENTIONAL SIMPLEX AND REPEATER SYSTEMS.....	8
UNDERSTANDING CTCSS/DCS/NAC.....	9
UNDERSTANDING TRUNKING.....	9
UNDERSTANDING MULTI-SITE TRUNKING.....	10
UNDERSTANDING IDS	10
INCLUDED WITH YOUR SCANNER	12
INSTALLING YOUR SCANNER	13
SETTING UP YOUR SCANNER	13
POWER RELATED ISSUES.....	13
BASE STATION.....	13
SETTING UP AN AUDIO RECORDING DEVICE OR COMPUTER RECORDING ..	14
VEHICLE INSTALLATION	15
Mounting Using the Bracket	15
Mounting Using the DIN-E Sleeve (Optional, Part No. DIN-0001).....	15
Removing the Scanner from the DIN-E Sleeve	16
Mounting Using ISO Technique	16
Removing the Display Sticker	17
Connecting an Optional Antenna	17
Connecting an Earphone/Headphone.....	17
Connecting an Extension Speaker.....	17
OPERATION BASICS	18
TURNING ON THE SCANNER AND SETTING THE SQUELCH.....	18
NAVIGATING THE MENU	18
KEYPAD AND KNOB CONTROLS.....	19
A LOOK AT THE DISPLAY	24
SETTINGS MENUS	28
Set Backlight	28
Adjust Key Beep.....	29

Set Upside-Down	29
Adjusting the Display Contrast	29
Set C-CH Output	29
Set GPS Format	29
Set GPS Baud Rate	30
Band Defaults	30
P25 LP Filter	30
Scanner Reset	31
PLANNING SYSTEMS, SITES, AND GROUPS	31
ENTERING TEXT	31
PROGRAMMING SYSTEMS	32
PRIVATE SYSTEMS	32
CONVENTIONAL SYSTEMS	32
Set Quick Key	33
Set Start-up Key	33
Set Number Tag	33
Set Lockout	33
Set Hold Time (in seconds)	33
Set Delay Time	34
Set Record	34
Set Audio AGC	34
P25 Waiting Time	34
PROGRAMMING TRUNKED SYSTEMS	35
COPYING AND DELETING SYSTEMS	39
CREATING SITES (SITE AUTOMATICALLY CREATED FOR EDACS SCAT)	39
P25 SYSTEMS	40
For Standard Motorola 800/900/Splinter Systems	41
For Custom (rebanding) Motorola/VHF/UHF Systems	41
PROGRAMMING TRUNKING SYSTEMS	44
CREATING SITES (SITE AUTOMATICALLY CREATED FOR EDACS SCAT)	49
CREATING GROUPS	53
PROGRAMMING FREQUENCIES/TGIDS	54
QUICKLY STORING A CONVENTIONAL FREQUENCY	54
QUICKLY STORING AN ID	55
MANUALLY PROGRAMMING CHANNEL FREQUENCIES/TGIDS	55
EDIT CHANNEL OPTIONS MENU	56
USING THE BCD996P2 WITH A GPS	60
LOCATION-BASED SCANNING	60
NON RADIO LOCATION-BASED GPS FEATURES	60
CONNECTING YOUR SCANNER	60

GPS DISPLAY MODE	62
GPS Review Location Mode	62
GPS REVIEW LOCATION MODE	66
PRIORITY/PRIORITY ID/PRIORITY PLUS SCAN	67
USING STARTUP KEYS	68
SCANNING SYSTEMS	69
USING NUMBER TAGS	72
OPTIMIZING P25 PERFORMANCE	73
LOCKING/UNLOCKING SYSTEMS/SITES/SEARCHES	73
LOCKING/UNLOCKING GROUPS	74
LOCKING/UNLOCKING CHANNELS	74
BAND SCOPE MODE	76
USING BAND SCOPE MODE	77
SEARCH/CLOSE CALL OPTIONS MENU	79
SEARCH FOR... MENU	81
EDITING A SERVICE SEARCH	82
Custom Search	85
Set Search Key	85
Auto Search and Store	85
Quick Search	86
Searching (only, not Search with Scan)	87
Storing a Displayed Frequency (while searching)	87
CLOSE CALL MENU	88
CLOSE CALL AUTO STORE	90
USING CLOSE CALL MODES	90
MANAGING CLOSE CALL HITS	91
In Close Call Only Mode	91
IN CLOSE CALL HOLD MODE	91
Hits with Scan	92
WEATHER OPERATION MENU	92
Using Fire Tone-Out	95
Setting up Tone-Out	95
In Tone-Out Standby Mode	97
In Tone-Out Search Mode	97
Key-Safe Mode	97
Preset Fleet Maps	99
Type II Special Status Bits	101
TECHNICAL SPECIFICATIONS	103
FREQUENCY RANGE	105

SPECIAL FUNCTIONS	106
Band Scope Function	106
Two-Tone-Sequential	106
WX Alert	106
Supported Trunking Systems.....	107
Heterodyne System.....	107
CTCSS Tones and DCS Tone Codes - 112 codes total.....	107
WARRANTY INFORMATION	108

IMPORTANT INFORMATION

THE FCC WANTS YOU TO KNOW

IMPORTANT! This scanning radio has been manufactured so that it will not tune to the radio frequencies assigned by the FCC for cellular telephone usage. The Electronic Communications Privacy Act of 1986, as amended, makes it a federal crime to intentionally intercept cellular or cordless telephone transmissions or to market this radio when altered to receive them. The installation, possession, or use of this scanning radio in a motor vehicle may be prohibited, regulated, or require a permit in certain states, cities, and/or local jurisdictions. Your local law enforcement officials should be able to provide you with information regarding the laws in your community.

MODIFICATION NOTICE

Changes or modifications to this product not expressly approved by Uniden, or operation of this product in any way other than as detailed by this Users Guide, could void your authority to operate this product.

PART 15 INFORMATION

This scanner has been tested and found to comply with the limits for a scanning receiver, pursuant to Part 15 of the FCC Rules. These limits are designed to provide reasonable protection against harmful interference in a residential installation. This scanner generates, uses, and can radiate radio frequency energy and, if not installed and used in accordance with the instructions, may cause harmful interference to radio communications.

There is no guarantee that interference will not occur in a particular installation. If this scanner does cause harmful interference to radio or television reception, which can be determined by turning the scanner on and off, you are encouraged to try to correct the interference by one or more of the following measures:

- Reorient or relocate the receiving antenna.
- Increase the separation between the scanner and the receiver.

This device complies with Part 15 of the FCC Rules. Operation is subject to the following two conditions: (1) this device may not cause harmful interference, and (2) This device must accept any interference received, including interference that may cause undesired operation.

This device complies with Industry Canada license-exempt RSS standard(s). Operation is subject to the following two conditions: (1) this device may not cause interference, and (2) this device must accept any interference, including interference that may cause undesired operation of the device.

Le présent appareil est conforme aux CNR d'Industrie Canada applicables aux appareils radio exempts de licence. L'exploitation est autorisée aux deux conditions suivantes : (1) l'appareil ne doit pas produire de brouillage, et (2) l'utilisateur de l'appareil doit accepter tout brouillage radioélectrique subi, même si le brouillage est susceptible d'en compromettre le fonctionnement.

SCANNING LEGALLY

Your scanner covers frequencies used by many different groups, including police and fire departments, ambulance services, government agencies, private companies, amateur radio services, military operations, pager services, and wireline (telephone and telegraph) service providers. It is legal to listen to almost every transmission your scanner can receive. However, there are some transmissions that you should never intentionally listen to.

These include:

- Telephone conversations (cellular, cordless, or other private means of telephone signal transmission)
- Pager transmissions
- Any scrambled or encrypted transmissions

According to the Electronic Communications Privacy Act (ECPA), you are subject to fines and possible imprisonment for intentionally listening to, using, or divulging the contents of such a conversation unless you have the consent of a party to the conversation (unless such activity is otherwise illegal). This scanner has been designed to prevent the reception of cellular telephone transmissions and the decoding of scrambled transmissions. This is done to comply with the legal requirement that scanners be manufactured so they are not easy to modify to pick up these transmissions. Do not open your scanner's case to make any modifications that could allow it to pick up transmissions that are illegal to monitor. Modifying or tampering with your scanner's internal components or using it in a way other than as described in this manual could invalidate your warranty and void your FCC authorization to operate it. In some areas, mobile and/or portable use of this scanner is unlawful or requires a permit. Check the laws in your area. It is also illegal in many areas (and a bad idea everywhere) to interfere with the duties of public safety officials by traveling to the scene of an incident without authorization.

AVIS D'INDUSTRIE CANADA

Le présent appareil est conforme aux normes CNR d'Industrie Canada applicables aux appareils radio exempts de licence. Son utilisation est assujettie aux deux conditions suivantes : (1) l'appareil ne doit pas produire de brouillage, et (2) l'utilisateur de l'appareil ne doit accepter tout brouillage radioélectrique qu'il reçoit, même si le brouillage est susceptible d'en compromettre le fonctionnement.

Une version française de ce guide d'utilisation est disponible sur le site Web d'Uniden au : www.uniden.com.

1. Sur le site d'Uniden, sélectionnez "Support", puis "Owner's Manuals".
2. Au menu déroulant de sélection des produits, choisissez "Scanners".
3. Sélectionnez le modèle et cliquez sur le drapeau canadien.
4. La version française du guide d'utilisation de ce modèle.

MAIN FEATURES

Trunk Tracker V Operation – Follows conversations on analog Motorola, Motorola Astro 25 (APCO 25) Phase I and Phase II, P25 One-Frequency Trunk, EDACS, EDACS SCAT, and LTR trunked radio systems, including systems in VHF, UHF, 700 MHz, 800 MHz, and 900 MHz bands.

APCO 25 Phase I and Phase II Support – Allows you to receive transmissions with these decoding protocols.

Dynamically Allocated Channel Memory – Organized into 'Systems', 'Sites', (within trunking systems), 'Groups' (within systems), and channels (within groups). Up to 500 systems, 1,000 total sites (max 256 per system), 20 groups per system, and 25,000 channels (500 max IDs or 1,000 frequencies per system).

Multi-Site Trunking – Lets you program the scanner to share trunked system IDs across multiple sites without duplicating IDs, and turn each site on and off independently so that you can select the best site to scan for your area.

Control Channel Only Scanning – Allows you to enter just the control channels to track a Motorola system and the scanner will find the voice channels.

System/Channel Number Tagging – Number tags allow you to quickly navigate to a specific system or channel. You can assign number tags to systems, channels, service searches, and custom search ranges. You can also assign a number tag to the 'Close Call' system created during 'Close Call Auto Store' and the temporary system 'Close Call Hits'.

Band Scope Mode – Band Scope mode is a special type of search mode where the scanner graphically displays the strength of any signal it finds.

Priority/Priority Plus Scan – Priority channels let you keep track of activity on your most important channels while monitoring other channels for transmissions and you can scan just the priority channels.

Priority ID Scan – Allows you to set priority to talkgroup IDs.

Preemptive Priority – A feature that works on Motorola systems. If the Motorola system has priority channels, and you assign one of those talkgroups as priority in the scanner, then when one of those channels becomes active, the scanner will jump to it even if it is on a different system voice channel (i.e. it preempts your current reception).

EDACS ESK Support – Provides the ability to monitor analog talkgroups on those systems.

Adjustable Scan/Search Delay/Resume – Set a delay up to 30 seconds or a forced resume up to 10 seconds. (per system or search).

Intermediate Frequency Exchange – Changes the IF used for a selected channel/frequency to help avoid image and other mixer-product interference.

Individual Channel Volume Offset – Allows you to adjust the volume offset for each channel.

Control Channel Data Output – Allows the analysis of control channel data without the need to perform invasive modifications to the scanner.

Private Systems – Lets you flag a system so that it cannot be read out of the scanner or modified (only with optional software).

Key Safe Mode – Lets you hand the scanner to a novice user and prevent programming from being modified.

Start-up Configuration – You can program each of your conventional systems, trunked sites, service searches, or custom searches with a 'Startup Key' (0-9) so that when you power up the scanner and press the key number, just those systems/sites/searches assigned to the key will be enabled for scan (groups are not affected).

Location-Based Scanning - Using an optional GPS unit you can scan your systems based on a set range from your current location.

GPS (Location-Based) Alerts - Notifies you when you are near an area you have programmed as a dangerous road, dangerous intersection, or a general point of interest.

Analog and Digital AGC - Helps automatically balance the volume level between different radio systems.

Adaptive Digital Threshold - Automatically sets the digital decode threshold for APCO 25 systems.

Preprogrammed Systems - Your scanner is preprogrammed with several conventional and digital agencies covering police, fire, and ambulance.

Search with Scan Operation - Lets you include and/or assign quick keys to selected service/custom search ranges during scan operation.

100 Quick Keys - You can scan conventional systems/trunked sites, groups, and searches by assigning them to quick keys.

3 Search Keys - You can assign 3 of the number keys to start a search range, Tone-Out search, or view the 'Band Scope' mode.

Temporary Lockout - Automatically unlock temporarily locked out channels/systems/searches/locations when you cycle power.

CTCSS/DCS/NAC Tone Decode - Decodes and displays Continuous Tone Code Squelch System tones being transmitted and plays Digital Coded Squelch and NAC being received.

CTCSS/DCS/NAC Search - Lets you search for CTCSS, DCS, or NAC tones when it finds an active frequency in search and close call modes.

Close Call RF Capture Technology - Lets you set the scanner so it detects and provides information about nearby radio transmissions. Close Call 'Do-not-Disturb' checks for Close Call activity in between channel reception so active channels are not interrupted.

Close Call Temporary Store - Temporarily stores and scans the last 10 Close Call hits in the 'Hits with Scan' system.

Fire Tone-Out Standby/Tone Search - Lets you set the scanner to alert you if a two-tone sequential page is transmitted. You can set up to 10 settings (transmit frequency, tone frequencies) then select one for standby monitoring. The scanner will also search and display unknown tones.

Frequency/ID Auto Search and Store - The scanner can be set to automatically store all active frequencies from a service or limit search in a conventional system you select or automatically store all new talkgroup IDs into a trunked system you select.

Custom Alerts - You can program your scanner to alert you when, a channel is received, you receive a Close Call hit, a talkgroup ID is transmitted with an emergency alert, you get close to a POI (Point of Interest)/Dangerous Road/Dangerous Crossing, or you receive a Tone-Out hit. For each alert in the scanner, you can select from 9 different tone patterns, 15 volume settings, 7 colors, and 2 color patterns.

Repeater Reverse - Allows the scanner to try to switch to the repeater input when monitoring a channel on a repeater system.

Broadcast Screen - Allows the scanner to ignore hits on known broadcast frequencies including pager frequencies in search and Close Call modes. You can also program up to 10 custom frequency ranges that the scanner will ignore.

Text Tagging - You can name each system, site, group, channel, talkgroup ID, custom search range, location, Tone-Out, and SAME group, using up to 16 characters per name.

SAME Weather Alert/Priority - (with programmable FIP codes) Lets your scanner alert you when a SAME weather alert is transmitted on a NOAA weather channel. The scanner also displays the alert type.

Adjustable Hold (Scan) Time per System/Search - allows you to adjust the length of time spent scanning each system or search.

Record-Out Jack - Lets you can connect an output jack to a VOX controlled recorder or PC sound input to record the received audio on selected channels, systems, Close Call, Fire Tone-Out, and searches.

ISO (or optional DIN-E) Vehicle Mountable - Using the optional DIN-E sleeve or a standard ISO technique, the scanner can be easily mounted in most vehicles.

Dimmer Circuit - A special wire lets you connect to the dimmer circuit of your vehicle so the vehicle's dimmer also dims the scanner's lighting.

PC Control/Clone - You can transfer data to and from your scanner or another scanner and your personal computer, and control the scanner using a computer using optional 3rd party software.

Multi-Level Display and Keypad light - Makes the display and keypad easy to see in dim light using 7 color options and three light levels.

Signal Strength Meter - Shows the signal strength for the more powerful transmissions.

12 Service Searches - Frequencies are preset in separate marine, railroad, air, CB radio, racing, FM broadcast, public safety, military air, FRS/GMRS, news, amateur radio, and special (itinerant) searches to make it easy to find specific transmissions.

10 Custom Searches - Lets you program up to 10 custom search ranges.

Quick Search - Lets you search from the currently-tuned frequency or channel or enter a frequency and start searching.

Automatic Channel Setup - Accepts frequencies on any valid channel step, even if it does not fall within the band plan's default steps.

Configurable Band Defaults - Allows you to set the step (5, 6.25, 7.5, 8.33, 10, 12.5, 15, 20, 25, 50 or 100 kHz) and modulation (AM, FM, NFM, WFM, or FMB) for 31 different bands.

Attenuator - You can set the scanner's attenuator to reduce the input strength of strong signals by about 20 dB per channel, search band, close call band, or trunked system.

Duplicate Frequency Alert - Alerts you if you try to enter a duplicate name or frequency already stored in the scanner.

Search Lockouts - You can lock out up to 500 frequencies (250 temporary, 250 permanent) in search or close call search.

SCANNING CONCEPTS

UNDERSTANDING DYNAMIC MEMORY

The scanner's memory is organized in an architecture called Dynamic Memory Access (DMA). This type of memory is organized differently and more efficiently than the bank/channel architecture used by traditional scanners. The DMA design matches how radio systems actually work much more closely and make it easier to determine how much memory you have used and how much you have left. No memory space is wasted.

Since you can only program one trunking system per bank in a traditional scanner, and let's say you only have 10 banks, you can only store 10 trunking systems. Also, since some trunked

systems might have hundreds of talkgroups you wish to monitor, you might have to enter those systems into multiple banks in order to monitor all the ID's.

Instead of being organized into separate banks and channels, the scanner's memory is contained in a pool. You build the systems and groups then use as much memory as you need in the pool to store frequencies, talkgroup ID's, and alpha tags. With all previous scanners, you selected banks to scan that had channels stored in them. With this scanner, you select conventional 'Systems' (or trunking 'Sites') to scan that have channel 'Groups' stored within the 'Systems'. Conventional systems have frequency groups and trunking systems have ID groups. For trunking systems, you have to create at least 1 'Site' (Motorola and EDACS only) or multiple sites first that hold the trunking frequencies for each site. The ID channel 'Groups' stored within the trunking systems can be used with all the sites.

You can store up to 20 'Groups' per 'System' with up to 1000 frequencies or 500 IDs in each 'Group'. You can have 1000 total channels per conventional system and up to 256 'Sites' if you have enough memory. You can have a maximum of 500 Systems, 1000 Sites, and 25,000 Channels.

UNDERSTANDING QUICK KEYS

There are 100 'System/Site/Search Quick Keys' (0-99) and 10 'Group Quick Keys' (0-9).

'Quick Keys' are used to turn conventional systems, trunking sites (not systems), channel groups, and custom/service searches on and off while scanning. This is not the same as locking out or unlocking systems/sites/groups/searches (which you can also do). They are just the number keys on the scanner but once assigned to systems/sites/groups/searches they become the 'Quick Key's. You can program one or more system/site/group/search to any quick key or, program one or more system/site/group/search with no quick key. Any conventional system, Close Call system, trunked site, group, service search, custom search, or 'Quick Save' system/group not assigned to a quick key (and/or not locked out) will be scanned.

It is best to assign everything to quick keys so you don't have to remember what to turn off/on or what to unlock/lockout. There are no indicators in the display showing systems/sites/groups with no quick key so you won't know if they are being scanned unless you see (or don't see) them scroll by in the display.

UNDERSTANDING CONVENTIONAL SIMPLEX AND REPEATER SYSTEMS

Simplex systems use a single frequency for both transmit and receive. Most radios using this type of operation are limited to line-of-sight operation. This type of radio is frequently used at construction job sites, and with inexpensive consumer radios such as GMRS/FRS radios. The range is typically 1-8 miles, depending upon the terrain and many other factors.

Repeater systems use two frequencies: one transmits from the radio to a central repeater; the other transmits from the repeater to other radios in the system. With a repeater based **system**, the repeater is located on top of a tall building or on a radio tower that provides great visibility to the area of operation. When a user transmits (on an input frequency), the signal is picked up by the repeater and retransmitted (on an output frequency). The user's radios always listen for activity on the output frequency and transmit on the input frequency. Since the repeater is located very high, there is a very large line of sight. Typical repeater systems provide coverage out to about a 25-mile radius from the repeater location.



UNDERSTANDING CTCSS/DCS/NAC

Continuous Tone Coded Squelch System (CTCSS) and Digital Coded Squelch (DCS) are two methods used to prevent interference by other radio communications. Your scanner can receive transmissions that use these codes (or more commonly referred to as tone codes).

CTCSS and DCS systems all use some form of coded squelch. Coded squelch techniques involve the transmission of a special 'code' signal along with the audio of a radio transmission. A receiver with coded squelch only activates when the received signal has the correct 'code'. This lets many users share a single frequency, and decreases interference caused by distant transmitters on the same channel. In all major metropolitan areas of the United States, every available radio channel is assigned to more than one user. Public safety radio systems on the same frequency are usually set up at a distance of 40 miles apart, or more. This means that you may hear transmissions from a distant system when your local system is not transmitting. By programming the CTCSS tone for a local channel the scanner will not stop on transmissions from the distant system. With few exceptions, such as the VHF Aircraft and Marine bands, almost every other VHF or UHF radio system uses some form of coded squelch. By far, CTCSS is the most popular mode among non-trunked systems.

NAC, similar to CTCSS/DCS, has a 3 digit hexadecimal code that is broadcast along with the digital signal being transmitted.

UNDERSTANDING TRUNKING

Trunking systems let a large group of 2-way radio users (or even different groups of 2-way radio users) efficiently use a set of frequencies. Instead of selecting a specific frequency for a transmission, the user's radio requests an unused frequency when that user presses their PTT (push to talk) button. The trunking system automatically assigns the call to the first available frequency, and also sends (on a different frequency called a Data or Control channel) a code that uniquely identifies that transmission as a talkgroup ID (or just ID) so that other users (and scanners) can follow the comm to the correct frequency. Trunking systems in general allocate and use fewer frequencies among many different users.

Since the trunking system might send a call and its response on different frequencies, it is difficult to listen to trunked communications using a conventional scanner. Trunk Tracking scanners let you monitor the control channel frequency so you can hear calls and responses for users and more easily "follow" conversations than with a conventional scanner.

This trunking scanner trunktracks the following types of systems:

<ul style="list-style-type: none"> • Motorola Type I • Motorola Type II • Motorola Type III Hybrid • Motorola Type II Smartnet • Motorola Type II Smartzone • Motorola Type II Smartzone Omnilink • Motorola Type II VOC • LTR Standard 	<ul style="list-style-type: none"> • Project 25 Standard • P25 X2-TDMA • P25 Phase I and Phase II • EDACS Standard (Wide) • EDACS Narrowband (Narrow) • EDACS Networked (Wide/Narrow) • EDACS SCAT • EDACS ESK
---	--

When you program Motorola/P25 and EDACS system frequencies into the scanner, one frequency is the control (or data) channel, and the rest are voice frequencies shared by all the users. There may be 3 or 4 frequencies assigned as (primary or alternate) control channels but only one control channel will be active at a time. These scanners will allow you to program just Motorola/P25 control channels into the trunking system and the voice channels will automatically



be found (but not programmed). EDACS systems need all the frequencies for the system programmed and with the correct LCN (Logical Channel Number) assigned.

The control channel is continually transmitted to the field units and has a sound similar to listening to a boat engine over the phone (in manual mode; you won't hear this when you are trunking the system.) This control channel is also a good check to see if you can trunktrack the system. If you can't hear a control channel when you step through the trunking frequencies (in manual mode) or can hear dropouts or interference, you either are too far away to receive the control channel and the system or there is some interference source that will inhibit tracking and reception. Motorola systems are limited to a maximum of 28 frequencies per site. EDACS systems are limited to 25 frequencies per site. Motorola and EDACS systems can be either analog, digital, or mixed (digital and analog talkgroups). Mixed Motorola systems should be programmed as Motorola systems and not P25 digital systems. That way the talkgroup options will allow you to select if it is a digital or analog.

LTR systems work a little differently. LTR systems typically do not have a dedicated control channel. This type of system encodes all trunking information as digital subaudible data that accompanies each transmission. The frequencies also have to have the LCN (Logical Channel Number) programmed for the scanner to trunktrack properly. Each repeater has its own controller, and all of these controllers are synchronized together. Even though each controller monitors its own channel, one of the channel controllers is assigned to be a master that all controllers report to. Each of these controllers sends out a data burst approximately every 10 seconds so that the subscriber units know that the system is there. This data burst is not sent at the same time by all the channels, but happens randomly throughout all the system channels. If you listen to the frequencies of an LTR system in manual mode (not trunking), on every channel in the system you will hear this data burst that will sound like a short blip of static like someone keyed up and unkeyed a radio within about 500 msec. LTR systems are limited to 20 frequencies per system.

When scanning a P25, Motorola, or EDACS trunked system, the scanner actually sits on a single frequency (the control channel) and compares the channel grants and channel updates in the data stream to the channels you have programmed in the scanner (in ID Scan mode; in ID Search mode, the scanner follows all channel grants for IDs you've not otherwise locked out). If there is a match, then the scanner jumps to the voice frequency that is carrying the traffic for that channel. The "scan speed" for a trunked system is actually determined by how long it takes for the site to transmit all channel grants and channel updates; typically 1-2 seconds per site.

UNDERSTANDING MULTI-SITE TRUNKING

Some Motorola and EDACS systems covering a very large geographic area use multiple antenna sites that each operate on different frequencies and use the same talkgroup IDs for traffic. Each site has its own set of trunking frequencies and is monitored like a single system. Each site can have its own quick key, so you can turn each individual site on or off while you scan. Program your talkgroups into channel groups within that system and all talkgroups in the system are available to every site so they don't have to be reprogrammed for each site. Since all sites share all the talkgroups within the system, multi-site trunking is much more efficient than programming each site as a separate system.

UNDERSTANDING IDS

IDs are what you see instead of frequencies when you monitor a trunking system.

Motorola IDs come in two display formats: Type I and Type II. Each format displays and uses talkgroup IDs in slightly different ways. Type I/II hybrid systems use both fleet-subfleet and 5-digit formats for talkgroup IDs.

Type I IDs are in the format FFF-SS where FFF is the fleet and SS is the sub-fleet. Type I systems are usually organized with different IDs assigned to different fleets. For example, a valid fleet/subfleet ID identifying all detectives within a police department might be 000-12, where 000 identifies all police IDs and 12 identifies the Detective division. To properly trunk a Type I system, you have to program the fleet map for the system.

Type II IDs are identified by a 5-digit number.

EDACS IDs come in two display formats: AFS and Decimal.

AFS IDs are in the form AA-FFS where AA is the agency, FF is the fleet, and S is the sub-fleet. EDACS systems are organized with different IDs assigned to different fleets and agencies. For example, a valid agency/fleet/subfleet ID identifying all detectives within a police department in an agency might be 06-101, where 06 identifies the agency (Police), 10 identifies the Police division (East side), and 1 identifies the Detective division.

Decimal IDs are shown as a decimal number from 0 to 2047.

I-Call IDS (Motorola/EDACS only) are direct unit-to-unit transmissions that are not heard by other system users. I-call IDs are usually 6-digit IDs (ex: 700152).







Unit IDS (or Radio IDs) are 7 or 8 digit numbers identifying individual radios.

Note: To view unit IDs you have to turn the option on in the 'Settings' menu.

LTR IDS are in the format A-HH-UUU where A is the area code (0 or 1), HH is the home repeater (01-20), and UUU is the user ID (000-254).

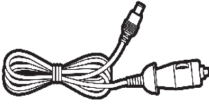
INCLUDED WITH YOUR SCANNER

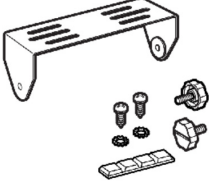
Accessories included in the box are:

		
<p>BCD996P2 Scanner</p>	<p>AC Adapter</p>	<p>Vehicle Accessory Power Cord</p>
		
<p>Three-Wire Harness</p>	<p>Mounting Bracket and Hardware</p>	<p>Antenna</p>
	<ul style="list-style-type: none"> • Owner's Manual (English and French) • APP Form • FREQ Form <p>Other Printed Materials</p>	

Not Shown: USB Cable

INSTALLING YOUR SCANNER

SETTING UP YOUR SCANNER

These guidelines will help you install and set up your new scanner:

The scanner can be placed on a convenient surface in your home as a base station, and connected to a standard outlet that supplies 120VAC, 60Hz. You must use either the supplied antenna or an electrically correct outdoor antenna, properly and safely mounted at your chosen site.

The scanner is also designed to accommodate either DIN-E and ISO-DIN automotive mounting configurations using a DIN-E sleeve and keys.

The unit can also be placed above, beneath, or in the dash of your vehicle using the supplied bracket and mounting hardware.

- If your scanner receives interference or electrical noise, move the scanner or its antenna away from the source.
- To improve the scanner's reception, use an optional external antenna designed for multi-band coverage. (You can purchase this type of antenna at a local electronics store). If the optional antenna has no cable, use 50Ω coaxial cable for lead-in. A mating plug might be necessary for the optional antennas.
- Use an optional stereo earphone or stereo headset with proper impedance (32 Ω) for private listening. Read the precautions at General Precautions.
- Do not use the scanner in high-moisture environments such as the kitchen or bathroom.
- Avoid placing the scanner in direct sunlight or near heating elements or vents.

POWER RELATED ISSUES

Important: To prevent memory from being corrupted, do not unplug the AC adapter during the time the memory is accessed for programming or auto store.

Notes:

- *If when you connect the AC adapter the [VOL]/Power Switch is ON, the scanner may not power on. Should this occur, simply turn the control OFF, then ON again.*
- *If the scanner loses power (as when you turn off your car's ignition with the scanner's power switch on), it can lose some system settings such as display color and backlight. To ensure that such settings persist, either change the setting using the scanner's menu or power the scanner off then back on using the power switch after making such setting changes.*

When you turn off the scanner using the power switch, the scanner remembers the last settings and mode. When you turn power back on, it resumes the previous mode.

BASE STATION

This is the simplest approach to let you get started quickly. Decide on a location that is convenient to a nearby wall outlet, has desk space to let you complete your programming worksheets, will safely allow the indoor antenna to be extended, or near a window to use an outdoor antenna.

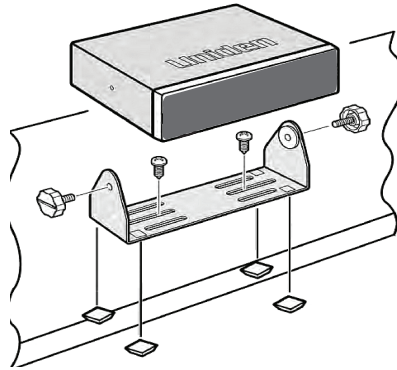

To secure the radio to a surface, by means of the mounting bracket, follow the steps below:

1. Attach the four protective mounting feet to the mounting bracket when you casually use the scanner on a flat surface. Should you desire to permanently mount the scanner, remove the feet and use wood screws through the bracket as described in Steps 2 and 3.
2. Use the bracket as a template to mark positions for the two mounting screws.
3. At the marked positions, drill holes slightly smaller than the screws.
4. Align the bracket with the threaded holes on the sides of the radio case so the bracket is beneath the radio. Secure the bracket using the two threaded knobs. Never overtighten the knobs.

Once the radio is positioned, connect it to a source of AC power using the supplied 13.8V, 750 mA AC adapter. Insert the barrel of the AC adapter to the jack on the rear, upper right side of the radio marked. Insert the connector of the supplied indoor telescoping antenna to the BNC Antenna Connector and apply moderate pressure to secure it.

SETTING UP AN AUDIO RECORDING DEVICE OR COMPUTER RECORDING

It is best if you plan ahead when you initiate the basic setup of the scanner if you include the components to record incoming reception. You need an audio recording device which can be controlled by a Voice Operated module (VOX) either externally or from within the unit and the correct connecting cable. The REC (record) jack on the rear cabinet provides a constant-level audio output which is not affected by the setting of the volume control. Use a mono or stereo cable that ends in a 3.5mm plug for the scanner. The recorder might have its own requirements as to the proper plug. Check the recorder's instructions to be sure. Connect the cable to an external or internal VOX control so that the recorder operates when audio is present.

You can also connect the cable to the appropriate input jack on your PC so that with controlling software, you can record to your hard disk.

In order for the function to operate, you must set the channel to record. You must also set the system's record option to either All Channel, which will record all channels regardless of any channel's setting, or Marked Channel which only lets recording occur if you have selected record for that channel. Which you choose will depend on various factors.

VEHICLE INSTALLATION

You can mount your scanner in your vehicle, using either the supplied bracket or the optional DIN-E sleeve.

Mounting Using the Bracket

With the bracket removed from the radio, use the holes in the bracket as a template to initially mark the location you plan to use in your vehicle. Be absolutely certain of what might be behind the mounting surface before making any holes, be it above, or below, or in front of your dash, armrest console, or other location. If you drill carelessly, expensive damage can result. If in doubt, consult your vehicle dealer's service department or a qualified professional installer.

Important: AVOID AIRBAG DEPLOYMENT ZONES. Ignoring this installation concern may result in bodily harm and the inability of the airbag to perform properly.

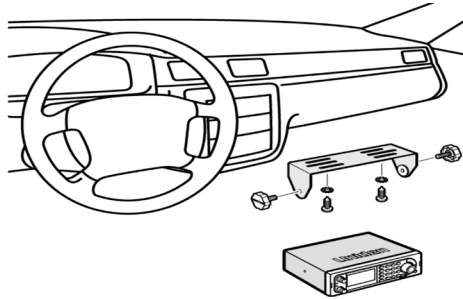

1. Using appropriate screws or other hardware, secure the bracket.
2. Insert the scanner and insert the bracket knobs to lock the scanner in position.
3. Attach the Cigarette Lighter Power Cord to the rear of the scanner and plug the adapter end into a dash mounted 12V DC socket.
4. Attach a suitable mounted mobile antenna to the antenna jack on the back of the scanner.

Mounting Using the DIN-E Sleeve (Optional, Part No. DIN-0001)

If you are unsure about how to install your scanner in your vehicle using the optional DIN-E sleeve, consult your automobile manufacturer, dealer, or a qualified installer. Before installing, confirm that your scanner fits in the desired mounting area and you have all the necessary materials to complete the task. Your scanner requires a 2 x 7-1/8 x 5-5/16 inch (50 x 180 x 135 mm) mounting area. Allow an additional 2-3/8 inch (60mm) space behind the unit for connectors and wires.

1. Remove the bracket if it is attached.
2. Remove the four Philips screws from four small tabs on the rear of the case that secure the outer metal case and pull off the case (toward the rear) with care.
3. Install the DIN sleeve into the opening in your dashboard, lip facing out.
4. Push out the top and bottom tabs to hold the sleeve firmly in place.
5. Before inserting the scanner in the sleeve, attach the cable from the previously mounted antenna. Attach the DC Power leads. RED goes to a positive (+) connection on your fuse block while BLACK connects to the vehicle's chassis ground (-).
6. Connect the ORANGE lead to one side of the headlamp switch so that when you activate the headlights, the scanner's LCD display changes intensity. Be sure all the connections are routed away from any potentially pinching or slicing sheet metal.

7. Slowly slide the scanner into the sleeve until it locks in place.
8. To remove the unit, fully insert the removal keys into each slot on the left and right edges of the front panel. Carefully slide the radio from the sleeve.

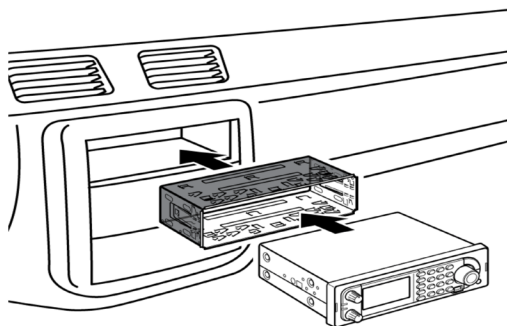

Note: If you plan to connect a GPS unit or external speaker at a later time, expect to remove the unit for ease of making those connections.

Removing the Scanner from the DIN-E Sleeve

If you plan to connect other devices or wires to the radio, such as a GPS unit, at a later time, you should plan to remove the scanner from the DIN-E sleeve. This is easily done using the provided Removal Keys that come with the optional DIN-E sleeve.

Refer to the illustration that follows, showing the Removal Keys.

Fully insert both Removal Keys into the slots on the left and the right edges of the radio's dress panel. You cannot remove the radio with only one key. Press in fully, and do not twist the keys. The radio will unlock from the sleeve making withdrawal from the sleeve possible. Store the keys in a safe place for future use.

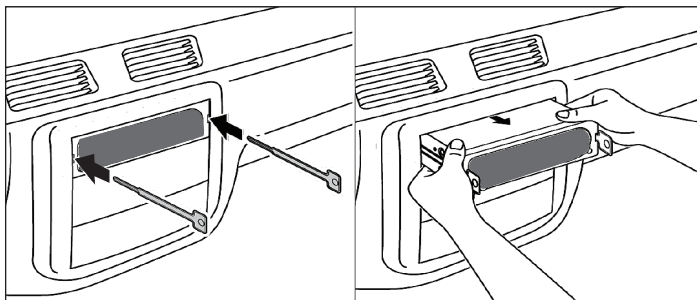

Mounting Using ISO Technique

Some vehicles can take advantage of another approach to mounting a radio in a vehicle, called the ISO technique. However, this technique requires a very detailed and thorough knowledge of the technique. Therefore, we strongly suggest that if you have any doubt about your experience and abilities, please consult with a professional installer who is familiar with the ISO approach to radio installation.

To begin the process, it is first necessary to remove the scanner's outer metal sleeve from the inner chassis. Unthread the four screws in the rear of the unit. Slide the cover toward the rear and off. Once the sleeve is removed, you will see threaded, metric machine screw holes on either side of the chassis cabinet. Uniden does not supply these screws. Their diameter, length, and screw type should be chosen by a qualified installer based on the internal vehicle bracket which will be used in securing the scanner chassis.

Once the original radio is removed from the vehicle dash and the fit of the scanner is correct, be sure to connect all the power, audio, antenna, and any other cables or wires, to the scanner before the scanner is secured.

The following illustration is a typical example of the ISO technique and the general side mounting screw holes often encountered. It does not actually represent the Uniden scanner nor your vehicle's mounting bracket. Only a professional installer will be able to determine the best and correct approach.

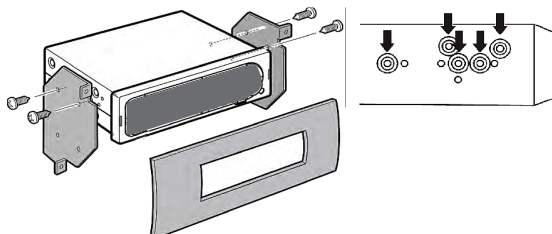

Removing the Display Sticker

Before you use the scanner for the first time, remove the protective plastic film over the display.

Connecting an Optional Antenna

The scanner's BNC connector makes it easy to connect a variety of optional antennas, including an external mobile antenna or outdoor base station antenna.

Note: Always use 50-ohm, RG-58, or RG-8, BNC terminated coaxial cable to connect an outdoor antenna. If the antenna is over 50 feet from the scanner, use RG-8 low-loss dielectric coaxial cable. Cable loss increases with higher frequency.

Connecting an Earphone/Headphone

For private listening, you can plug a 1/8-inch (3.5 mm) mini-plug earphone or headphones (not supplied) into the headphone jack on the front of your scanner. This automatically disconnects the internal speaker. See the Earphone Warning for important information about using an earphone/headphone.

WARNING!

Never connect anything other than the recommended amplified extension speaker to the scanner's headphone jack. Damage to the scanner might occur.

Connecting an Extension Speaker

In a noisy area, an optional amplified extension speaker, positioned in the right place, might provide more comfortable listening. Plug the speaker cable's 1/8-inch (3.5-mm) mini-plug into your scanner's back panel Ext. Sp. Jack.

WARNING!

Never connect any part of the headphone jack to the antenna jack or connect the radio to an installation where the antenna and audio connection are grounded. This might also damage the scanner.

OPERATION BASICS

TURNING ON THE SCANNER AND SETTING THE SQUELCH

Note: this applies to a fresh scanner right out of the box or one that has been reset with the preprogrammed systems reloaded.

Rotate **VOL** clockwise to turn on the scanner and set the volume to around 6-8. The scanner should start scanning after the welcome screen disappears or will display Nothing to Scan if nothing has been programmed into the scanner, yet—in that event tune to a local weather channel to set the volume. Press **HOLD**. Find a comfortable volume level. Rotate the **SQ** knob counterclockwise all the way then clockwise until the noise stops, then one notch more. Press **HOLD** to resume scanning.

Right away you may want to check these settings in the 'Settings' menu. Set *Backlight/Dimmer*, *Adjust Key Beep*, *Adjust Contrast*, and *Set Serial Port* (if you plan to upload/download).

Right out of the box you can do a service search, custom search, weather scan, auto search and store, close call search, or close call auto store. To listen to local systems, you first must program them into the scanner.

NAVIGATING THE MENU



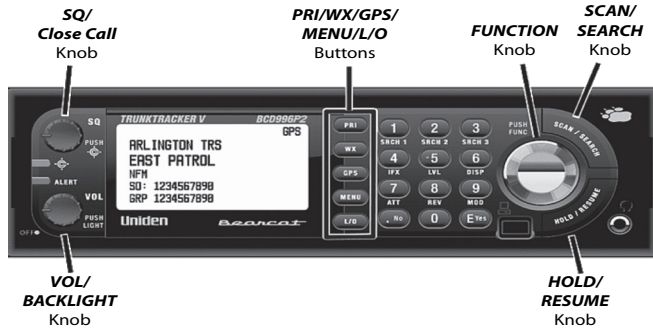

The scanner's menu lets you select options that let you set up and use the scanner using the **MENU** key. To select a menu item, rotate the scroll control clockwise or counterclockwise. The currently selected menu item is highlighted with a bar on the display. When the menu item you want to select is highlighted, press **E/Yes** or (the scroll control) to select it.

To back up a level, press **MENU**. To exit all menus press **L/O** or **SCAN**.

KEYPAD AND KNOB CONTROLS









Each of the knobs and keys on the BCD996P2 produce several different results depending upon how you activate them. You can, for example, rotate the knobs as well as press them. Some keys provide one operation when briefly pressed while pressing and holding a key or knob gives a different result. Many controls and keys behave differently depending on the mode your radio is in when you use the key or control.

Key	Function
SQ (Squelch)	<ul style="list-style-type: none"> Turn to adjust the squelch. Press  to toggle Close Call DND, Close Call Priority, or Close Call Off in Any Mode except Tone-Out and GPS. Press and hold to turn on Close Call Only in Any Mode except GPS. Press  then SQ to start Fire Tone-Out in Any Mode except GPS.
  ALERT	<ul style="list-style-type: none"> The blue light flashes with a Close Call hit. The red light flashes once then stays on for a weather alert for about 3 minutes. The red light stays on for a Dangerous Road/Crossing alert until canceled (locked out).
VOL, Light	<ul style="list-style-type: none"> Turns the scanner on/off and adjusts the volume. Press to toggle through the backlight intensities in Any Mode. Press  then VOL to view the APCO threshold display in Any Mode.
PRI	<ul style="list-style-type: none"> Press to toggle Priority On, Priority Plus, Priority Off in Scan Mode (at least one conventional priority channel must be assigned).
WX	<ul style="list-style-type: none"> Press to toggle Weather Alert Priority on/off in Any Mode except GPS. Press and hold to start Weather Scan in Any Mode except GPS. Press to switch to Weather Scan in Weather Alert Mode. Press to switch to Weather Alert in Weather Scan Mode.

Key	Function
GPS	<ul style="list-style-type: none"> • Press to switch to GPS mode in Any Mode. • Press and hold to store (overwrite) current location (with a GPS device connected) in GPS Display/Review Location Mode.
MENU	<ul style="list-style-type: none"> • Press to enter Menu Mode. • Press to return to previous menu. • Press to go to a channel and/or a system number tag after entering. • Press to return to GPS mode in Review Location Mode. • Press ⏏ then MENU to go to the 'Edit' menu for the current system in Scan Mode. • Press ⏏ then MENU to go to the 'Search for...' menu in Search Mode. • Press ⏏ then MENU to go to the 'Close Call' menu in Close Call Only Mode. • Press ⏏ then MENU to go to the 'WX Operation' menu in Any Weather Mode. • Press ⏏ to go to the 'Edit' menu for the current POI in GPS Display Mode. • Press ⏏ to go to the 'Tone-Out for...' menu in Tone-Out Standby/Search.
L/O	<ul style="list-style-type: none"> • Press to toggle the temporary lockout status of a channel in Scan Mode. Double press for permanent lockout. • Press to toggle the temporary lockout status of a frequency in Search Mode. Double press for permanent lockout. • Press to toggle the lockout status of a location in GPS Review Location Mode. • Press and hold to unlock (and enable) all groups and channels in a system in Scan Hold Mode. • Press and hold to unlock all frequencies of all search ranges/Close Call in Search Hold Mode. • Press and hold to unlock all locations of the current type (POI, DRD, or DXG) in GPS Review Location Mode. • Press ⏏ then L/O to review and unlock search frequencies in Search/Close Call Only Modes. • Press ⏏ then L/O to toggle the lockout status of a conventional system/site/search in Scan Hold Mode. • Press ⏏ then press and hold L/O to unlock (and enable) all systems, groups, channels, and search ranges in Scan Mode. • Press ⏏ to unlock all locations of all types (POI, DRD, or DXG) in GPS Review Location Mode. • Press to exit Menu Mode or return to the last mode

Key	Function
Number Keys	<ul style="list-style-type: none"> • Enter any 3-digit channel number tag then MENU to access a channel in the current system in Scan Hold Mode. • Enter any 3-digit system number tag then .No then any 3-digit channel number tag then MENU to access a channel in another system in Scan Hold Mode. • Enter any frequency/ID then Hold to go directly to in Scan/Search Hold Modes. • Press 0-9 to toggle single-digit system/site/search quick keys on or off in Scan Mode. • Press 0-9 to toggle custom searches on or off in Search Mode. • Press 1-7 to toggle Close Call bands on or off in Close Call Only Mode. • Press 4 to move the cursor to the left when editing text. • Press 6 to move the cursor to the right when editing text. • Press ☐ then 0-9 to toggle group quick keys on or off in Scan Mode. • Press ☐ then 1(Srch 1), 3(Srch 3) to turn search keys on in Any Mode except GPS. • Press ☐ then 4(IFX) to toggle intermediate frequency exchange for a channel/frequency in Scan/Search/Weather Hold Modes. • Press ☐ then 5(LVL) to toggle the volume offset for a channel in Scan Hold Mode. • Press ☐ then 6(DISP) to toggle display modes (1, 2, or 3) in Scan Hold Mode. • Press ☐ then 7(ATT) to toggle the attenuator on/off for a conventional channel in Scan Hold Mode. • Press ☐ then 7(ATT) to toggle the attenuator on/off for a trunked site in Scan Hold Mode. • Press ☐ then 7(ATT) to toggle the attenuator on/off in Search/Close Call Only/Tone-Out/Weather Modes. • Press ☐ then press and hold 7(ATT) to toggle global attenuation on/off in Any Hold Mode except GPS. • Press ☐ then press and hold 8(REV) to view the repeater frequency in Scan/Search/Close Call Only Hold Modes. • Press ☐ then press 9(MOD) to toggle the modulation for a conventional channel in Scan Hold Mode. • Press ☐ then press 9(MOD) to toggle the modulation for a search/Close Call/Tone-Out in Search Mode.

Key	Function
.No	<ul style="list-style-type: none"> • Press to cancel an error or warning message. • Press to enter a decimal point after a system number tag. • Press before entering a 2-digit system/site/search quick key to turn on or off in Scan Mode. • Press to enter a decimal point for a frequency while programming. • Press to enter a hyphen when entering an ID while programming. • Press to enter an 'i' when entering an 'I-Call' ID while programming. • Press once to delete current character when editing text. • Press twice to delete all characters when editing text.
E/Yes	<ul style="list-style-type: none"> • Press to select a menu item or save an entry in Menu Mode. • Press to store a (blinking) CTCSS/DCS/NAC tone in Scan Mode. • Press to store an ID in 'ID Search' mode while scanning a trunked system in Scan Mode. • Press to 'quick store' a frequency in Search/Close Call Only/ Weather Modes. • Press to store found tones in Tone-Out Search Mode. • Press to enter the Menu Mode for the current Tone-Out in Tone-Out Mode. • Press to enter the Menu Mode for a displayed channel in Scan Mode. • Press to enter 'Review Location' menu in GPS Display Mode.
 /Scroll Control	<ul style="list-style-type: none"> • Press to enter Function mode for 4 seconds. • Press and hold to lock Function Mode. Press again to unlock. • Press to select a menu item or save an entry in Menu Mode. • Turn to scroll to a menu item in Menu Mode. • Turn to select characters when editing text. • Turn to select scan/search direction and to continue scan/search in Scan/Search Modes. • Turn to select channel or frequency in Scan/Search Hold Modes. • Turn to select POIs in GPS Display Mode. • Turn to select locations GPS Review Location Mode. • Turn to temporary lock out an alert in GPS Display Mode. • Turn to select Tone-Outs in Tone-Out Standby. • Press  then turn  to scroll to systems/sites/searches in Scan Mode. • Press  then turn  to skip to the location that starts with the next letter of the alphabet in GPS Review Location Mode.

Key	Function
SCAN/SEARCH	<ul style="list-style-type: none"> • Press to start/continue/resume scanning in Scan/GPS Modes. • Press to start/continue/resume searching in Search Mode. • Press  then SCAN/SEARCH to start a 'quick search' at the current frequency while scanning a conventional system in Scan Receive/Hold Modes. • Press  then then SCAN/SEARCH to change from 'ID Scan' to 'ID Search' while scanning a trunking site in Scan Mode.
HOLD/RESUME	<ul style="list-style-type: none"> • Press to hold on a channel, frequency, search, Close Call hit, or Tone-Out search. Press again to resume. • Press to hold in Band Scope Mode. • Press to recall the last Close Call Hit in Close Call Only Mode. • Press and hold to hold on a system in Scan mode. Press and hold to resume.

A LOOK AT THE DISPLAY

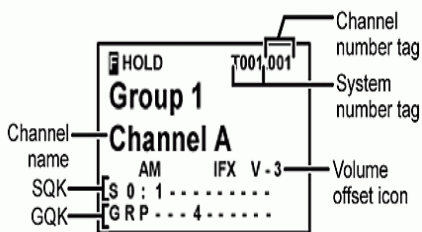

Conventional Display Mode 1 (Function Mode)

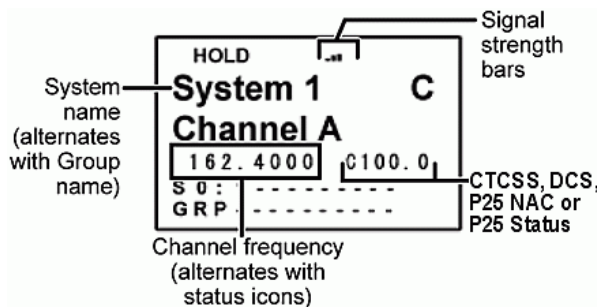

Conventional Display Mode 2

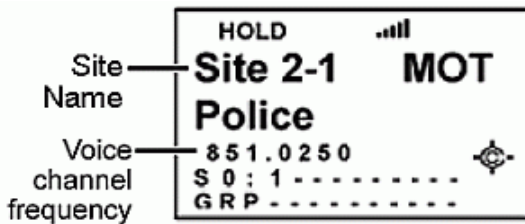

Trunking Display Mode 1

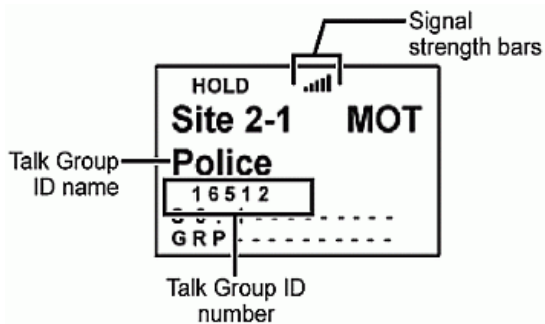

Trunking Display Mode 2

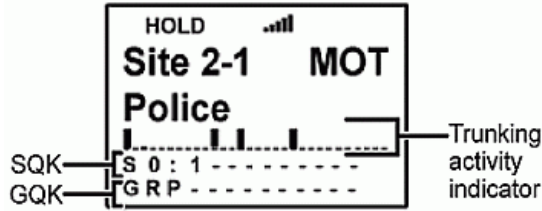

Trunking Display Mode 3

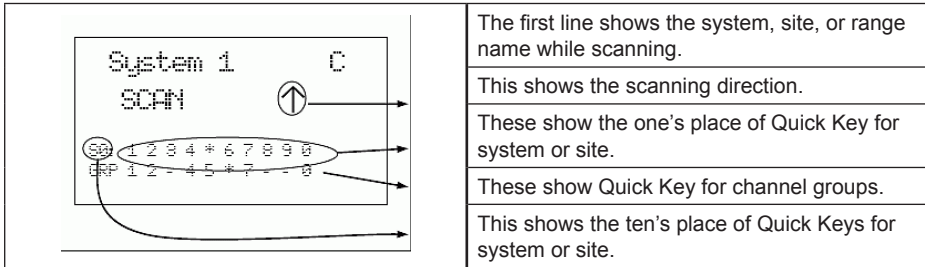

The display has indicators that show the scanner's current operating status. The display information helps you understand how your scanner operates.

First Line	
	Displays when you press the Func key to select Function Mode in Any Mode. Displays and blinks when you press and hold the Func key to lock Function Mode in Any Mode.
HOLD	Appears in Hold Mode
L/O	Appears if the system/site/group/channel/frequency/search/location is locked out in Hold Mode. Displays the system number tag and channel number tag (if programmed) in Function Mode.
PRI	Appears in priority mode and blinks in priority plus mode in Scan Mode.
	Displays to show the signal strength of the receiving channel or frequency.
GPS	Appears if the scanner is connected to a GPS device and receiving a signal in Any Mode.
Second Line	
<ul style="list-style-type: none"> Shows the name of the currently scanned site or conventional system in Scan Mode. Displays the name of the currently searched custom/service search in Search Mode. Alternates the conventional system name and channel group name for a conventional system in Scan Receiving/Hold Modes. Alternates the site name and channel group name for a trunking system in Scan Receiving/Hold Modes. Alternates the custom search name and system name for a trunking system for a 'C-Ch only Search' in Receiving or Hold Modes in display modes 1 and 3. 	

- Will alternate the custom search name and system name for a trunking system for a 'C-Ch only Search' in Receiving or Hold Modes in display modes 1 and 3.
- Will alternate the custom search name and 'SID' for a trunking system for a 'C-Ch only Search' in Receiving or Search Hold Modes in display mode 2.

Third Line

- Will scroll 'SCAN' (for a conventional system), 'ID SCAN', or 'ID SEARCH' (for a trunked system) and show an up or down arrow to indicate the scan direction in Scan Mode.
- Will display the search frequency range/channels and an up or down arrow to show the scan direction in Search Mode.
- Displays the frequency for a conventional channel or will alternate the ID (or text tag if programmed) with the Unit ID (if for a trunking system in Scan Receiving/Hold Modes.
- Displays the ID (with C-Ch only on) in Search Receive or Hold Modes.

Fourth Line - Display Mode 1

In addition to the following codes, the Fourth Line also:



- Displays the acquired control channel frequency of a trunking site in Scan Mode.
- Displays the modulation and attenuation (if on) of a non-acquired trunked site in Scan Mode.
- Displays the voice channel of a trunked site in Scan Receiving/Hold Modes.
- Displays the receive modulation of the conventional channel in Scan Receiving/Hold Modes.
- Displays the receive modulation of the custom/service search in Search Mode.
- Displays the tone code (if received) for a conventional frequency if programmed and blinks in CTCSS/DCS/NAC search mode in Receiving or Hold Modes.
- Displays the volume offset for the channel in Function Hold Mode.

P	Displays when receiving a conventional priority channel in Receiving or Hold Modes.
ATT	Displays if the channel/search is attenuated in Receiving or Hold Modes.
IFX	Displays if intermediate exchange is on for the channel in Function Hold Mode.
P25	Displays if the channel is receiving digitalized voice in Scan Receiving/Hold Modes.
PT0	Displays if the channel is receiving Phase II time slot 0.
PT1	Displays if the channel is receiving Phase II time slot 1.
PX0	Displays if the channel is receiving X2 Time slot 0.
PX1	Displays if the channel is receiving X2 Time slot 1.
LNK	Displays if the channel is receiving data in Scan Receiving/Hold Modes.
DAT	Displays if the control channel is being received in Scan Receiving/Hold Modes.
ENC	Displays if the channel is receiving encrypted voice in Scan Receiving/Hold Modes.

Fourth Line - Display Mode 2

In addition to the following codes, the Fourth Line also:

- Displays the acquired control channel frequency of a trunking site in Scan Mode.
- Displays the modulation and attenuation (if on) of a non-acquired trunked site in Scan Mode.
- Displays the ID for a trunking site in Scan Receiving/Hold Modes

	<ul style="list-style-type: none"> • Displays the frequency for a conventional channel in Scan Receiving/Hold Modes. • Displays the receive modulation of the custom/service search in Search Mode.
ATT	displays if the search is attenuated in Receiving or Search Modes. displays the tone code (if received) for a conventional frequency if programmed and blinks in CTCSS/DCS/NAC search mode in Receiving or Hold Modes.
IFX	Displays if intermediate exchange is on for the channel in Function Hold Mode. Displays the volume offset for the channel in Function Hold Mode
Fourth Line - Display Mode 3	
Displays only the trunking activity indicators for a trunked system in Scan, Receiving, or Hold Modes. Conventional system/search display is the same as Display mode 1.	
Fifth Line	
S0-9:	Displays the first digit of (systems/sites/search assigned to) the currently scanned quick key on the left with the blinking second digit (1-0) on the right in Scan/Receiving Modes. Displays the first digit of the system/site/search quick key assigned to the displayed channel on the left with the second digit (1-0) on the right in Hold Mode. <ul style="list-style-type: none"> • a - (dash) means nothing is assign to the quick key. • an * (asterisk) means the quick key is turned off.
	Displays if the Close Call 'Priority' feature is on in Any Mode except GPS and Tone-Out.
	Displays reversed if the Close Call 'Do-Not-Disturb' feature is on in Any Mode except GPS and Tone-Out.
SCR	Displays if one or more broadcast/custom screen bands are turned on in Search/Receiving Modes.
REP	Displays if repeater reverse is turned on in Search/Receiving Modes.
Sixth Line	
GRP	Displays the group quick keys (1-0) for each conventional system/site with (groups assigned to) the currently scanned quick key blinking in Scan/Receiving Modes. Displays the group quick key for the displayed channel in Hold Mode. <ul style="list-style-type: none"> • a non-blinking number on the right indicates the quick key is enabled waiting to be scanned. • - (dash) means nothing is assigned to the quick key. • an * (asterisk) means the quick key is turned off.
WX	Displays if the weather alert priority feature is on in Any Mode except GPS and Tone-Out.
GPS	Alert information displays if connected to a GPS device and receiving a signal in Scan or Search Modes.

BAND DEFAULTS

Frequency Range	Step (kHz)	Mode	Band	Frequency Range	Step (kHz)	Mode
25-27.405	5	AM	CB/Business	174-215.95	50	WFM
27.41-27.995	5	AM	Business/Forest	216-224.98	20	NFM
28-29.68	20	NFM	10 Meter Ham	225-379.975	25	AM

29.7-49.99	10	NFM	VHF Low	380-399.9875	12.5	NFM
50-53.98	20	NFM	6 Meter Ham	400-405.9875	12.5	NFM
54-71.95	50	WFM	VHF TV	406-419.9875	12.5	NFM
72-75.995	5	FM	Astronomy	420-449.9875	12.5	NFM
76-87.95	50	WFM	VHF TV	450-469.9875	12.5	NFM
88-107.9	100	FMB	FM Broadcast	470-512	12.5	NFM
108-136.9916	8.33	AM	Commercial Air	758-787.99375	6.25	NFM
137-143.9875	12.5	NFM	Military Land Mobile	788-805.99375	6.25	NFM
144-147.995	5	NFM	2 Meter Ham	806-823.9875	12.5	NFM
148-150.7875	12.5	NFM	Military Land Mobile	849.0125-868.9875	12.5	NFM
150.8-161.995	5	NFM	VHF High	894.0125-960	12.5	NFM
162-173.9875	12.5	NFM	Federal	1240-1300	25	NFM

When you select "Auto" for a channel or mode's modulation or step, the above values are used unless you've edited the Band Defaults. Although TV bands are listed, the scanner cannot decode digital TV audio.

SETTINGS MENUS



To Edit Settings press **MENU**. Scroll to 'Settings' and press **E/** .

Scroll to the settings and options below (in Blue) and press **E/** .





Set Backlight	Set GPS Format
Adjust Contrast	P25 Threshold
See Scanner Info	Firmware Version and Serial Number
Adjust Key Beep	Set Upside-Down
Set C-CH Output	Set GPS Baud Rate
P25 LP Filter	Disp. Unit ID
% Memory Used	Cloning
-	Scanner Reset

Set Backlight

You can also change the intensity by pressing **VOL** to toggle your desired level to Off, High, Middle, or Low. Set the dimmer to Auto if you are going to hard-wire your scanner inside your vehicle.



1. Scroll to 'Set Backlight' and press **E/** .
2. Scroll to 'Set Dimmer' press **E/** .
3. Scroll to 1 of 2 options and press **E/** .

For vehicle use - Scroll to 'Auto' and press **E/** .

4. Scroll to 1 of 2 options and press **E/**  to save and exit.
 - '+ Polarity' - if the orange wire gets 12V when you turn on the headlights.
 - '- Polarity' - if the orange wire is switched to chassis ground when you turn on the headlights.
 For vehicle use - Scroll to 'Manual' and press **E/** .
5. Scroll to 'High', 'Middle', 'Low', or 'Off' and press **E/**  to save and exit.
6. Scroll to 'Set Color' and press **E/** .
7. Scroll to Off, Blue, Red, Magenta, Green, Cyan, Yellow, or White and press **E/**  to save and exit.
8. Press **MENU** to return.



Adjust Key Beep

This setting turns the key beep on or off and adjusts the volume level.

1. Scroll to 'Adjust Key Beep' and press **E/** .
2. At 'Set Level' scroll to 'Level 1-15 or Auto' (the scanner sets the alert beep to the master volume level) and press **E/**  to save and exit.

Set Upside-Down

This setting allows you to reverse the display so you can mount the scanner upside-down and hear the speaker from the top.

1. Scroll to 'Set Upside-down' and press **E/** .
2. Scroll to On or Off and press **E/**  to save and exit.





Adjusting the Display Contrast

This setting controls the display's contrast.

1. Scroll to 'Adjust Contrast' and press **E/** .
2. At 'Contrast 1-15' scroll to the preferred contrast level and press **E/**  to save and exit.

Set C-CH Output







Allows you to choose how you want the scanner to handle control channel data output.

1. Scroll to 'Set C-CH Output' and press **E/** .
2. Scroll to 1 of 3 options and press **E/** .
 - Off** - The scanner will not output the control channel data.
 - On** - The scanner will output the control channel data.
3. At 'Select Comm Port' scroll to 'Front Port' or 'Rear Port' and press **E/** .
 - Extend** - The scanner will output the control channel data along with any description.
4. At 'Select Comm Port' scroll to 'Front Port' or 'Rear Port' and press **E/** .

Set GPS Format



Allows you to set the GPS format to DD,MM,SS or decimal degrees (DD.000000), time format, time zone, and units.

1. Scroll to 'Set GPS Format' and press **E/** .
2. Scroll to 'Pos Format' and press **E/** .

3. Scroll to 'DMS:DDD MM"SS.ss' or 'DEG:DDD.dddddd' and press **E/**  to save and exit.
4. Scroll to 'Set Time Format' and press **E/** .
5. Scroll to '12H' or '24H' and press **E/**  to save and exit.
6. Scroll to 'Set Time Zone' and press **E/** .
7. Scroll to 'Your Time Zone' and press **E/**  to save and exit.
8. Scroll to 'Set Unit' and press **E/** .
9. Scroll to 'mile' or 'km' and press **E/**  to save and exit.
10. Press **MENU** to return.

Set GPS Baud Rate



Allows you to set the baud rate for the front and rear serial ports. You typically set the front port to match the speed used to communicate with BC-GPSK (default 4800 bps) and the back port to the speed used to communicate with an attached GPS device (default 4800 bps). Note that the back port is male. You may need a gender changer and a null modem adapter to use a typical DB9 serial cable from the rear port.

1. Scroll to 'Set GPS Baud Rate' and press **E/** .
2. Scroll to Off, 4800, 9600, 19200, 38400, 57600, or 115200 and press **E/**  to save and exit.
3. Press **MENU** twice to return.

Band Defaults



This setting allows you change the 'Auto' values you can select while programming frequencies, searches, etc. to whatever you feel 'Auto' should be for each band (vs. the radio defaults). Since all of the step and modulation settings default to 'Auto', this allows you to skip those settings when programming.

Note: these setting have no effect on service searches.

1. Scroll to the band you wish to edit and press **E/** . Refer to Auto Step Size chart to help find the bands in the menu.
2. At 'Set Modulation' scroll to AM, NFM, FM, WFM, or FMB (Broadcast) and press **E/**  to save and exit.
3. At 'Set Step' scroll to Auto, 5, 6.25, 7.5, 8.33, 10, 12.5, 15, 20, 25, 50, or 100 kHz and press **E/**  to save and exit.
4. Scroll to any other bands you wish to edit and repeat. Press **MENU** to return

P25 LP Filter

This setting lets you set the scanner to apply a software filter that removes the 4kHz tone you can hear on some P25 systems. Note that turning on ~ and install the latest firmware upgrade for the scanner if you don't already have it. Check the Wiki to find all the information necessary to upgrade your firmware.

1. Scroll to 'See Scanner Info' and press **E/** .
2. Scroll to 'Firmware Version' and press **E/** .
3. Press **MENU** twice to return.

Scanner Reset

Allows to initialize the scanner's memory, turn off the scanner. Then press **2**, **9**, and **HOLD** while turning it on.

Important! This deletes all programmed data.

PLANNING SYSTEMS, SITES, AND GROUPS

Planning your systems will be very important even if you use 3rd party software to program the scanner. Organizing your Quick Keys will be the most important part of the planning. You can assign quick keys and copy and paste most of the frequencies, alpha tags, and IDs easily into the software. **To Enter a Character**, turn the scroll control until the character you want appears.

You will have to determine what quick key to assign to each conventional systems/trunked sites and groups so you can scan them with some sort of logic you can remember.

Number Tags Numbers for system and channel tags can range from 0 to 999. Multiple systems can have the same number tag but you will get a warning. The same warning applies to channels. You can assign number tags to channels even if the system does not have a number tag but, without a system number tag, you can only navigate to these channels while holding or scanning in that system. See also Using Number Tags.

If two systems/searches have the same number tag, they will be selected in sequence (the first time you select the number tag, the scanner will go to the first system/search assigned to that number tag; if you select the same number tag again, it will go to the 2nd system/search assigned to that number tag, and so on). The same rule applies to channel number tags (so don't start at 1 for each channel group in the system).

Alerts You can program your scanner to alert you when, a channel is received, you receive a Close Call hit, a talkgroup ID is transmitted with an emergency alert, you get close to a POI (Point of Interest)/Dangerous Road/Dangerous Crossing, or you receive a Tone-Out hit. For each alert in the scanner, you can select from 9 different tone patterns, 15 volume settings, 7 colors, and 2 color patterns. For more info visit the Wiki alerts page.

Startup Keys you can program each of your conventional systems, trunked sites, service searches, or custom searches with a 'Startup Key' (0-9) so that when you power up the scanner and press the key number, just those systems/sites/searches assigned to the key will be enabled for scan (groups are not affected). See also Using Startup Keys.

ENTERING TEXT

To program text you must first program the system, site, group, channel, location, custom search, Tone-Out, or SAME group.

To enter a letter, turn the scroll control until the character you want appears.

(character order clock-wise is upper-case, lower-case, numbers, then special characters).• To enter a decimal point, press **.No**.

- To enter a decimal point, press **.No**.
- To move the cursor to the right, press **6**.
- To move the cursor to the left, press **4**.
- To clear a character or enter a space, press **.No**.
- To clear all characters, press **.No** twice.

PROGRAMMING SYSTEMS







You have to create systems first, create sites in the trunking systems (where the trunking frequencies go), create groups in the systems, create channels in the groups, then program the frequencies or IDs into the channels. Or, you can Quick store freqs or Quick store IDs (only after you program the trunking system and site). Trunking IDs only go into trunking system groups and conventional frequencies only go into conventional system groups. You can only store one trunking system per 'system'. You can store up to 500 systems, up to 20 groups per system, and up to 1000 frequencies or 500 IDs per group. Total channels are limited to about 25,000. Also, remember that conventional frequencies and IDs are considered channels. Note: Once a system has been created, the system type cannot be changed.

One suggestion; assign a quick key to every (conventional) system/(trunked) site/group (and search you want to include with scan). You can assign as many systems/sites you want to a quick key and as many groups you want to a group quick key. That way you can just turn systems/sites/groups on and off and not have to worry about locking them out. If you do not assign systems/sites/groups to a quick key, you have to lock it out if you do not want to scan it.

PRIVATE SYSTEMS





You can flag a system only in the software so that it cannot be read out of the scanner, modified, or deleted. There are no settings in the scanner to do this. You can still use the system as you would normally (system/channel lockouts/unlock, volume offset, attenuate, etc), you just can't access it in the menu. Also, you cannot upload the system back to the scanner and have to delete it with the software.

CONVENTIONAL SYSTEMS

1. To Create a New Conventional System press **MENU**.
2. At 'Program System' press **E/** .
3. At 'Select System' scroll to 'New System' and press **E/** .
4. At 'Select Sys Type' scroll to 'Conventional' and press **E/** .
5. At 'Confirm?' press **E/** .
6. At 'Edit Name' press **E/** .
7. Scroll to 'Edit Sys Option' and press **E/** .



Continue at 'Set Quick Key' below, then refer to Creating Groups and Programming Frequencies/IDs.

To Edit Conventional System Options:

1. Press **MENU**.
2. At 'Program System' press **E/** .
3. At 'Select System' scroll to the system that you want to edit and press **E/** .
4. Scroll to 'Edit Sys Option' and press **E/** .
5. Scroll to the options below and press **E/** .
6. Press **SCAN/SEARCH** to return to scanning when you have completed editing.

Set Quick Key



Assigns a quick key to a system. The system will be scanned when its quick key is enabled. The default setting is no quick key.

1. Scroll to 'Set Quick Key' and press **E/** .
2. Scroll to the quick key number (0-99 or .No for no quick key) you want assigned to the system and press **E/**  to save and exit.

Note: *Pressing the first number of a 2-digit quick key will get you closer, 1 for 10, 2 for 20, etc. then scroll to second digit.*



Set Start-up Key

Allows you to automatically lock or unlock a system when you turn on the scanner. If you hold down the system's start-up key while turning on the scanner, the system (and other systems assigned to the same key) will be unlocked, and systems with different start-up keys will be locked out (systems with no start-up key assigned will not be affected). This does not affect the quick key status, only the lock/unlock status. The default setting is no startup key.

1. Scroll to 'Set Startup Key' and press **E/** .
2. Scroll to (or enter) the startup key number (**0-9** or **.No** for no startup key) you want assigned to the system and press **E/**  to save and exit.



Set Number Tag

Allows you to number a system for rapid access. The default setting is no number tag (blank). See also Using Number Tags.

1. Scroll to 'Set Number Tag' and press **E/** .
2. Enter the number tag (**0-999**) (Press **.No** to clear the display) and press **E/**  to save and exit.

Set Lockout



Determines whether a system will be scanned or not (even if the quick key for the system is turned on). 'Temporary L/O' locks out the system until you cycle power. The default setting is unlocked.

1. Scroll to 'Set Lockout' and press **E/** .
2. Scroll to 'Temporary L/O', 'Unlocked' or 'Locked' and press **E/**  to save and exit.

Note: *You can also toggle system lockout by holding on the system in scan mode and pressing **E/**  then L/O.*



Set Hold Time (in seconds)

Determines the amount of time the scanner will scan the system before moving on to the next system. When set to 0, all (unlocked) channels will be scanned at least once. The scanner moves to the next system after the hold time expires, any current transmission ends, and the channel delay time expires. The default setting is 0 seconds for each system.

1. Scroll to 'Set Hold Time' and press **E/** .
2. Enter the hold time (**0-255** seconds) you desire and press **E/**  to save and exit.



Set Delay Time

Sets the delay (in seconds) the amount of time the scanner stays on a channel after the transmission ends before moving to the next channel. A negative delay forces a resume after that number of seconds. This setting applies to all channels in the system. You cannot set the delay on a 'per channel' basis. The default setting is 2 seconds.

1. Scroll to 'Set Delay Time' and press **E/** .
2. Scroll to the desired delay time (-10, -5, -2, 0, 1, 2, 5, 10, or 30 secs.) and press **E/**  to save and exit.

Set Record

Enables the REC jack for marked channels, no channels, or all channels in the system. The default setting is Off.

1. Scroll to 'Set Record' and press **E/** .
2. Scroll to one of 3 settings and press **E/**  to save and exit.



All Channel - The scanner sends the audio for all channels in the system to the REC jack, regardless of the channel's record option setting.

Marked Channel - The scanner only sends the audio for channels that have the record option turned on to the REC jack.

Off - The scanner does not send any audio from any channel in the system to the REC jack, even if the record option is turned on for a channel.



Set Audio AGC

Allows you to turn the AGC feature on or off for the system. See also Adjust Audio AGC.

1. Scroll to 'Set Audio AGC' and press **E/** .
2. Scroll to 'Analog' and press **E/**  to toggle on or off.
3. Scroll to 'Digital' and press **E/**  to toggle on or off.
4. Press **MENU** to return.



P25 Waiting Time

This setting sets the amount of time the scanner takes to determine if channels on conventional systems have digital or analog transmissions. During this time, the scanner evaluates the received signal and, if it detects P25 data, opens squelch immediately. If P25 is not detected before the delay expires, the scanner opens squelch at the end of this delay. This is to prevent "false decode" problems (digital noise at the beginning of transmissions). The default setting is 400 ms. This setting only affects conventional channels with an Audio Type set to 'All'.



1. Scroll to 'P25 Wait Time' and press **E/** .
2. Set the Wait Time from 0 to 1000 ms and press **E/** .

Note: Any analog transmissions on channels with Audio Type set to All lose the first part of the transmission, up to the wait time you set here.

To Edit the System Name:





1. Press **MENU**.
2. At 'Program System' press **E/** .
3. At 'Select System' scroll to the system you want to name and press **E/** .
4. At 'Edit Name' press **E/** . See Entering Text.

To Copy a System:

1. Press **MENU**.
2. At 'Program System' press **E/** .
3. At 'Select System' scroll to the system you want to copy and press **E/** .
4. Scroll to 'Copy System' and press **E/** .
5. At 'New Sys Name?' see Entering Text to name the new system.







Copying a system copies all sites, groups, channels, and settings including quick key assignments.

To Delete a System:

1. Press **MENU**.
2. At 'Program System' press **E/** .
3. At 'Select System' scroll to the system and press **E/** .
4. Scroll to 'Delete System' and press **E/** .
5. At 'Confirm Delete' press **E/** .







PROGRAMMING TRUNKED SYSTEMS

To Create a New P25 System:

1. Press **MENU**.
2. At 'Program System' press **E/** .
3. At 'Select System' scroll to 'New System' and press **E/** .
4. At 'Select Sys Type' scroll to 'P25' and press **E/** .
5. Scroll to 'Standard Trunk' or 'One-Freq Trunk' and press **E/** .
6. At 'Confirm?' press **E/** .
7. At 'Edit Name' press **E/** . See Entering Text.
8. Scroll to 'Edit Sys Options' and press **E/** .

Continue at 'Set Number Tag' below then refer to Creating Sites and Creating Groups. Finally, refer to Programming Frequencies/IDs.





To Create a New Motorola System:

1. Press **MENU**.
2. At 'Program System' press **E/** .
3. At 'Select System' scroll to 'New System' and press **E/** .
4. At 'Select Sys Type' scroll to 'MOT' and press **E/** .
5. At 'Confirm?' press **E/** .
6. At 'Edit Name' press **E/** . See Entering Text.
7. Scroll to 'Edit Sys Options' and press **E/** .



Continue at 'Set Number Tag' below, then refer to Creating Sites, Creating Groups, and Programming Frequencies/IDs.

To Create a New EDACS System:

1. Press **MENU**.







2. At 'Program System' press **E/** .
3. At 'Select System' scroll to 'New System' and press **E/** .
4. At 'Select Sys Type' scroll to 'EDCS' and press **E/** .
5. Scroll to 'WIDE/NARROW' or 'SCAT' and press **E/** .
6. At 'Confirm?' press **E/** .

Note: EDACS Wide is the same as EDACS Standard and use a 9600 baud control channel. EDACS Narrow-band systems use a 4800 baud control channel. RadioReference has a description of SCAT.

7. At 'Edit Name' press **E/** . See Entering Text.
8. Scroll to 'Edit Sys Options' and press **E/** .





Continue at 'Set Number Tag' below, then refer to Creating Sites, Creating Groups, and Programming Frequencies/IDs.

To Create a New LTR System:

1. Press **MENU**.
2. At 'Program System' press **E/** .
3. At 'Select System' scroll to 'New System' and press **E/** .
4. At 'Select Sys Type' scroll to 'LT' and press **E/** .
5. At 'Confirm?' press **E/** .
6. At 'Edit Name' press **E/** . See Entering Text.
7. At 'Edit Name' press **E/** . See Entering Text.

Continue at 'Set Number Tag' below, then refer to Edit Site Options, Creating Groups, and finally Programming Frequencies/IDs.

To Edit Trunking Systems Options:



1. Press **MENU**.
2. At 'Program System' press **E/** .
3. At 'Select System' scroll to the system that you want to edit and press **E/** .
4. Scroll to 'Edit Sys Option' and press **E/** .
5. Scroll to the options below and press **E/** .
6. Press **SCAN/SEARCH** to return to scanning when you have finished editing.

Note: Not all options will appear for EDACS SCAT and LTR systems.



Set Number Tag allows you to number a system.

The default setting is no number tag (blank).

See also Using Number Tags.

1. Scroll to 'Set Number Tag' and press **E/** .
2. Enter the number tag (**0-999**) (Press **.No** to clear the display) and press **E/**  to save and exit.

ID Scan/Search (no EDACS SCAT) sets whether the scanner scans the programmed ID groups (ID Scan) or searches for all IDs (ID Search) in a trunking system. The default setting is ID search.

1. Scroll to 'ID Scan/Search' and press **E/** .
2. Scroll to 'ID Scan' or 'ID Search' and press **E/**  to save and exit.

Note: You can also toggle this while scanning each trunked system by pressing **ESC** then **SCAN/SEARCH**.

Set Delay Time sets the delay (in seconds) the amount of time the scanner stays on a channel after the transmission has ended before moving to the next channel. A negative delay will force a resume after that number of seconds. This setting applies to all channels in the system. You cannot set the delay on a 'per channel' basis. The default setting is 2 seconds.

1. Scroll to 'Set Delay Time' and press **ENTER**.
2. Scroll to the desired delay time (-10, -5, -2, 0, 1, 2, 5, 10, or 30 secs.) and press **ENTER** to save and exit.

Edit Fleetmap (Motorola Type I/III systems only) allows you to select a preprogrammed fleetmap or program a fleetmap for Motorola Type I systems. You must program a system fleet map in order for the scanner to properly track and display talkgroup ID's.

1. Scroll to 'Edit Fleetmap' and press **ENTER**.
2. To select a Preset Fleetmap, scroll to 'Preset' and press **ENTER**.
3. Scroll to the number of the preset fleetmap and press **ENTER** to save and exit. See Preset Fleetmaps.
4. To program a Custom Fleetmap, scroll to 'Custom' and press **ENTER**.
5. At 'Block 0' scroll to the size code (0-14) and press **ENTER**. See Size Codes.
6. The scanner will prompt you to the next available block so you can scroll to and enter the next size code (**0-14**) then press **ENTER**.
7. Repeat for each block as needed (**0-7**) and you will return to the 'Edit Sys Option' menu.

Note: If you select size code 12, 13, or 14, these restrictions apply:

- 12 can only be assigned to Blocks 0, 2, 4 or 6.
- 13 can only be assigned to Blocks 0 and 4.
- 14 can only be assigned to Block 0.

Since these size codes require multiple blocks, you will be prompted for the next available block. For example, if you assign Block 0 as 12, the scanner prompts you for block 2, the next block available, instead of block 1. If you assign Block 0 as 14, you would not see another prompt because 14 uses all available blocks.

Priority ID Scan (no EDACS SCAT/P25-1Tr) allows you to use Priority Scan with IDs.

1. Scroll to 'Priority ID Scan' and press **ENTER**.
2. Scroll to 'On' or 'Off' and press **ENTER**.

Set Status Bit (Motorola only) sets how your scanner works with status bits (also called S-bits), letting you control how the scanner interprets and displays Motorola talkgroup IDs. The default setting is ignore.

1. Scroll to 'Set Status Bit' and press **ENTER**.
2. Scroll to one of two settings and press **ENTER** to save and exit.

Yes - the scanner treats all received ID's as unique ID's.

Ignore - the scanner rounds all received ID's down to the next interval of 16.

Set End Code (Motorola only) sets how the scanner handles the transmission end code sent by most Motorola systems.

1. Scroll to 'Set End Code' and press **ENTER**.







2. Scroll to one of three settings and press **E/** .

Analog - The scanner recognizes only analog end transmission codes.



Analog+Digital - The scanner recognizes both analog and digital end codes.

Ignore - The scanner waits for the carrier to drop before leaving a channel.



Emergency Alert (Motorola/EDACS only) sets how your scanner handles IDs that have the emergency flag set. The default setting is off.

1. Scroll to 'Emergency Alert' and press **E/** .
2. Scroll to 'Set Alert Tone' and press **E/** .
3. At 'Set Tone' scroll to the alert (Alert 1-9 or Off) and press **E/** .
4. At 'Set Level' scroll to 'Level 1-15 or Auto' (the scanner sets the alert beep to the master volume level) and press **E/** .
5. Scroll to 'Set Alert Light' and press **E/** .
6. Scroll to Off, Blue, Red, Magenta, Green, Cyan, Yellow, or White and press **E/** .
7. At 'Set Pattern' scroll to On, Slow Blink, or Fast Blink and press **E/** .
8. Press **MENU** to return.

Set ID Format (DEC/HEX for Motorola or AFS/DEC for EDACS) sets the ID format for the system.

1. Scroll to 'Set ID Format' and press **E/** .
2. (Motorola) Scroll to 'Decimal Format' or 'Hex Format' and press **E/**  to save and exit.
(EDACS) Scroll to 'AFS Format' or 'Decimal Format' and press **E/** to save and exit. Scroll to 'Set ID Format' and press **E/** .

Set Record enables or disables the REC jack for all channels or marked channels in the system.



1. Scroll to 'Set Record' and press **E/** .
2. Scroll to one of 3 settings and press **E/**  to save and exit.

All Channel - The scanner sends the audio for all channels in the system to the REC jack, regardless of the channel's record option setting.



Marked Channel - The scanner only sends the audio for channels that have the record option turned on to the REC jack.

Off - The scanner does not send any audio from any channel in the system

Rvw ID:Srch L/O (no EDACS SCAT) allows you to review locked out IDs in a system and unlock them.



1. Scroll to 'Rvw ID:Srch L/O' and press **E/** .
2. At 'Unlock?' scroll to the ID and press **E/**  to unlock.
'Nothing Locked' appears if nothing is locked out.
3. Press **MENU** to return.

Clr All L/O IDs (no EDACS SCAT) allows you to unlock all the locked IDs in a system.



1. Scroll to 'Clr All L/O IDs' and press **E/** .
2. At 'Confirm?' press **E/**  to save and exit.
'Nothing Locked' appears if nothing is locked out.
3. Press **MENU** to return.

Set Audio AGC allows you to turn the AGC feature on or off for the system. See also Adjust Audio AGC.

1. Scroll to 'Set Audio AGC' and press **E/** .

2. Scroll to 'Analog' and press **E/**  to toggle on or off.
3. Scroll to 'Digital' and press **E/**  to toggle on or off.
4. Press **MENU** to return.

P25 NAC Option (P25-1Tr only) allows you to have the scanner search for NAC codes or you can program a specific code for the system.



1. Scroll to 'P25 NAC Option' and press **E/** .
2. Scroll to one of two settings and press **E/** .

Search - The scanner opens squelch for any digital signal and displays the NAC being used.

Set P25 NAC - The scanner opens squelch only for signals that include the programmed NAC.



3. At 'Input P25 NAC' see Entering Text.

To Edit the System Name:

1. Press **MENU**.
2. At 'Program System' press **E/** .
3. At 'Select System' scroll to the system you want to name and press **E/** .
4. At 'Edit Name' press **E/** . See Entering Text.





COPYING AND DELETING SYSTEMS

To Copy a System:

1. Press **MENU**.
2. At 'Program System' press **E/** .
3. At 'Select System' scroll to the system you want to copy and press **E/** .
4. Scroll to 'Copy System' and press **E/** .
5. At 'New Sys Name?' see Entering Text to name the new system.

Copying a system copies all sites, groups, channels, and settings including quick key assignments.

To Delete a System:





1. Press **MENU**.
2. At 'Program System' press **E/** .
3. At 'Select System' scroll to the system and press **E/** .
4. Scroll to 'Delete System' and press **E/** .
5. At 'Confirm Delete' press **E/** .

CREATING SITES (SITE AUTOMATICALLY CREATED FOR EDACS SCAT)

Once you have created a trunking system and configured the System Options you can create your sites. All trunked systems need at least one site to enter trunking frequencies.





To Create a Site:

1. Press **MENU**.

2. At 'Program System' press **E/** .
3. At 'Select System' scroll to the system where you want to create a site and press **E/** .
4. Scroll to 'Edit Site' and and press **E/** .
5. At 'Select Site' scroll to 'New Site' and press **E/** .

Continue at 'Edit Name' below, and then see Creating Groups and Programming Frequencies/IDs.

To Edit Site Options:



1. Press **MENU**.
2. At 'Program System' press **E/** .
3. At 'Select System' scroll to the system that has the site you want to edit and press **E/** .
4. Scroll to 'Edit Site' and and press **E/** .
5. At 'Select Site' scroll to the site you want to edit and press **E/** .
6. Scroll to the options below and press **E/** .
7. Press **SCAN/SEARCH** to return to scanning when you have completed editing.

Note: Not all options will appear for EDACS SCAT and LTR sites.

Edit Name (no EDACS SCAT) assigns a name to the site.

Scroll to 'Edit Name' and press **E/** . See Entering Text.

Set Quick Key assigns quick key to a site and will be scanned when the key is turned on. The default setting is no quick key.

1. Scroll to 'Set Quick Key' and press **E/** .
2. Scroll to the quick key number (**0-99** or **.No** for no quick key) you want assigned to the site and press **E/** .

Note: Pressing the first number of a 2-digit quick key will get you closer, 1 for 10, 2 for 20, etc. then scroll to second digit.





Set Start-up Key allows you to turn on the scanner with the site enabled for scan using the Startup Configuration. The default setting is no startup key.

1. Scroll to 'Set Startup Key' and press **E/** .
2. Scroll to (or enter) the startup key number (**0-9** or **.No** for no startup key) you want assigned to the site **E/**  to save and exit.

Edit Band Plan (Motorola Custom/P25/VHF/UHF only) Band plans are required so the scanner can correctly determine the voice channel frequencies.

P25 SYSTEMS

For P25 Systems there are two types of P25 systems: Explicit mode and Implicit mode. Most P25 systems use Explicit mode. Explicit mode systems transmit all information needed to determine voice frequencies on the control channel. For Explicit mode systems, leave all entries blank. The system automatically detects the band plan and fills in the entries. You must supply the system's band plan for Implicit systems for the scanner to correctly determine voice frequencies.



1. Scroll to 'Edit Band Plan' and press **E/** .
2. At 'Select Plan' scroll to 'Band Plan 0-9, A-F' and press **E/** .
3. At 'Input Base Freq' enter the base frequency and press **E/** .
4. At 'Input Spacing' enter the step size and press **E/** .

Repeat for each band plan as needed. Press **MENU** to return.

For Standard Motorola 800/900/Splinter Systems

Splinter - analog 800Mhz systems with frequencies between 866-869 MHz.











Rebanded - 851-854 MHz ending with 0 instead of 5 e.g. 852.1250, not 852.1375.

1. Scroll to 'Edit Band Plan' and press **E/** .
2. Scroll to '800/900 Standard' or '800 Splinter' and press **E/** . The scanner will use the normal Motorola band plan and return to the menu.

For Custom (rebanded) Motorola/VHF/UHF Systems

This settings lets you create a custom band plan. Custom band plans require that you enter both a lower and an upper base frequency value. The lower base frequency (or base) is always the base frequency as provided in the Radio Reference Database.

Follow the instructions and use the spreadsheet at <http://info.uniden.com/UnidenMan4/CalculatingUpperBaseFrequencies> to determine the upper base frequency value.

1. Scroll to 'Edit Band Plan' and press **E/** .
2. At 'Select Plan' scroll to 'Band Plan 1-6' and press **E/** .
3. At 'Set Base Freq' press **E/** .
4. At 'Input Lower' enter the lower base frequency and press **E/** .
5. At 'Input Upper' enter the upper base frequency and press **E/** .
6. Scroll to 'Set Offset' and press **E/** .
7. At 'Input Offset' enter the offset and press **E/** .
8. At 'Select Polarity' scroll to + or - and press **E/** .
9. Scroll to 'Set Spacing and press **E/** .
10. Scroll to the step size and press **E/** .
11. Press **MENU** to return and repeat for each band plan as needed. Press **MENU** to return.

For Standard Motorola 800 MHz rebanded systems you need to set Band Plan 1 and Band Plan 2 as follows:



Band Plan	Lower Base Freq	Upper Base Freq	Offset	Polarity	Spacing
1	851.0250	854.0000	440	+	25 kHz
2	851.0125	868.9875	0	+	25 kHz



Set Site Type (EDACS only) this is where you select a Wideband or Narrowband EDACS site.

1. Scroll to 'Set Site Type' and press **E/** .
2. Scroll to 'Wide (Standard)' or 'Narrow' and press **E/**  to save and exit.









Note: EDACS Wide is the same as EDACS Standard and uses a 9600 baud control channel. EDACS Narrow-band sites use a 4800 baud control channel.

Set Frequencies this is where you program or change the trunking frequencies, delete frequencies, or lock them out.



1. Scroll to 'Set Frequencies' and press **E/** .
2. At 'Set Frequency' scroll to 'New Frequency' and press **E/** .

3. At 'Input Frequency' enter the frequency and press **E/** .
4. For EDACS and LTR sites only, at 'Input LCN' enter the LCN number and press **E/** .
5. Scroll to 'New Frequency' and press **E/**  to enter more frequencies.
6. Press **MENU** twice to return to the 'Edit Site' menu.

To Edit Frequencies:



1. Scroll to 'Set Frequencies' and press **E/** .
2. At 'Set Frequency' scroll to the frequency you want to edit and press **E/** .
3. Scroll to 'Edit Frequency' press **E/** . Edit the frequency and press **E/**  to save and exit.
4. For EDACS and LTR sites only, at 'Input LCN' enter the LCN number and press **E/** .
5. Scroll to 'Set Lockout' and press **E/** .
6. Set the lockout status and press **E/**  to save and exit.
7. To delete a frequency, scroll to 'Delete Frequency' press **E/** . At 'Confirm Delete' press **E/** . You will return to the 'Edit Site' menu.
8. Press **MENU** twice to return to the 'Edit Site' menu.

Set Modulation this setting selects the modulation used for the site. The default setting is auto. See also Band Defaults.

1. Scroll to 'Set Modulation' and press **E/** .
2. Scroll to Auto, NFM, or FM and press **E/** .



Note: You can also toggle modulation for a site in scan hold mode by pressing  then **9(MOD)**.

Set Attenuator this setting controls whether the scanner attenuates signals on this site by about 20 dB. The default setting is off.

1. Scroll to 'Set Attenuator' and press **E/** .
2. Scroll to On or Off and press **E/**  to save and exit.



Note: You can also toggle attenuation for a site in scan hold mode by pressing  then **7(ATT)**.

Set Lockout determines whether a site will be scanned or not (even if the quick key for the site is turned on). 'Temporary L/O' locks out the site until you cycle power. The default setting is unlocked.

1. Scroll to 'Set Lockout' and press **E/** .
2. Scroll to 'Unlocked', 'Temporary L/O', or 'Lockout' and press **E/**  to save and exit.



Note: You can also toggle lockout by holding on the site and quickly pressing  then **L/O**.

Set Hold Time sets (in seconds) the amount of time the scanner will scan the system before moving on to the next system. All (unlocked) channels will be scanned at least once regardless of this setting. The scanner moves to the next system after the hold time expires, any current transmission ends, and the channel delay time expires. The default setting is 0 seconds for each system.



1. Scroll to 'Set Hold Time' and press **E/** .
2. Enter the hold time (0-255 seconds) you desire and press **E/**  to save and exit.

Set Delay Time sets the delay (in seconds) the amount of time the scanner stays on a channel after the transmission has ended before moving to the next channel. A negative delay will force

a resume after that number of seconds. This setting applies to all channels in the system. You cannot set the delay on a 'per channel' basis. The default setting is 2 seconds.

1. Scroll to 'Set Delay Time' and press **E/** .
2. Scroll to the desired delay time (-10, -5, -2, 0, 1, 2, 5, 10, or 30 secs.) and press **E/**  to save and exit.

Set Record enables the REC jack for marked channels, no channels, or all channels in the system. The default setting is Off.



1. Scroll to 'Set Record' and press **E/** .
2. Scroll to one of 3 settings and press **E/**  to save and exit.

All Channel - The scanner sends the audio for all channels in the system to the REC jack, regardless of the channel's record option setting.



Marked Channel - The scanner only sends the audio for channels that have the record option turned on to the 'REC' jack.

Off - The scanner does not send any audio from any channel in the system to the REC jack, even if the record option is turned on for a channel.

Set Audio AGC allows you to turn the AGC feature on or off for the system. See also Adjust Audio AGC.



1. Scroll to 'Set Audio AGC' and press **E/** .
2. Scroll to 'Analog' and press **E/**  to toggle on or off.
3. Scroll to 'Digital' and press **E/**  to toggle on or off.
4. Press **MENU** to return.

P25 Waiting Time this setting basically gives the scanner time to determine if channels on conventional systems have digital or analog transmissions. During this time, the scanner will evaluate the received signal and, if it detects P25 data, will open squelch immediately. If P25 is not detected before the delay expires, the scanner will open squelch at the end of this delay. This is to prevent "false decode" problems (digital noise at the beginning of transmissions). The default setting is 400 ms. This setting only affects conventional channels with an Audio Type set to 'All'.



1. Scroll to 'P25 Wait Time' and press **E/** .
2. Set the Wait Time from 0 to 1000 ms and press **E/** .

Note: Any analog transmissions will lose the first part of the transmission, up to the wait time you set here.

To Edit the System Name:

1. Press **MENU**.
2. At 'Program System' press **E/** .
3. At 'Select System' scroll to the system you want to copy and press **E/** .
4. At 'Edit Name' press **E/** . See Entering Text.





To Copy a System:

1. Press **MENU**.
2. At 'Program System' press **E/** .
3. At 'Select System' scroll to the system you want to copy and press **E/** .
4. Scroll to 'Copy System' and press **E/** .

5. At 'New Sys Name?' see Entering Text to name the new system **E/** .

Copying a system will copy all sites, groups, channels, and settings including quick key assignments.







To Delete a System:

1. Press **MENU**.
2. At 'Program System' press **E/** .
3. At 'Select System' scroll to the system and press **E/** .
4. Scroll to 'Delete System' and press **E/** .
5. At 'Confirm Delete' press **E/** .

PROGRAMMING TRUNKING SYSTEMS







Note for Motorola/P25 systems: If you are not sure if the system is Motorola or P25, look at the system voice in the RR database for your system. Those entries that say System Voice: Analog and APCO-25 Common Air Interface are not true Project 25 systems as they have one or more analog talkgroups. Program these systems as a Motorola system and let the scanner detect the digital. If the System Voice says System Voice: APCO-25 Common Air Interface Exclusive then the system is a true Project 25 system and program it as a P25 system.

To Create a New P25 System:

1. Press **MENU**.
2. At 'Program System' press **E/** .
3. At 'Select System' scroll to 'New System' and press **E/** .
4. At 'Select Sys Type' scroll to 'P25' and press **E/** .
5. Scroll to 'Standard Trunk' or 'One-Freq Trunk' and press **E/** .
6. At 'Confirm?' press **E/** .
7. At 'Edit Name' press **E/** . See Entering Text.
8. Scroll to 'Edit Sys Options' and press **E/** .





Continue at 'Set Number Tag' below. Then see Creating Sites. Then see Creating Groups. Then see Programming Frequencies/IDs.

To Create a New Motorola System:



1. Press **MENU**.
2. At 'Program System' press **E/** .
3. At 'Select System' scroll to 'New System' and press **E/** .
4. At 'Select Sys Type' scroll to 'MOT' and press **E/** .
5. At 'Confirm?' press **E/** .
6. At 'Edit Name' press **E/** . See Entering Text.
7. Scroll to 'Edit Sys Options' and press **E/** .

Continue at 'Set Number Tag' below. Then see Creating Sites. Then see Creating Groups. Then see Programming Frequencies/IDs.

To Create a New EDACS System:







1. Press **MENU**.
2. At 'Program System' press **E/** .
3. At 'Select System' scroll to 'New System' and press **E/** .
4. At 'Select Sys Type' scroll to 'EDCS' and press **E/** .
5. Scroll to 'WIDE/NARROW' or 'SCAT' and and press **E/** .
6. At 'Confirm?' press **E/** .

Note: EDACS Wide is the same as EDACS Standard and use a 9600 baud control channel. EDACS Narrow-band systems use a 4800 baud control channel. RadioReference has a description of SCAT.

7. At 'Edit Name' press **E/** . See Entering Text.
8. Scroll to 'Edit Sys Options' and press **E/** .





Continue at 'Set Number Tag' below. Then see Creating Sites. Then see Creating Groups. Then see Programming Frequencies/IDs.

To Create a New LTR System:

1. Press **MENU**.
2. At 'Program System' press **E/** .
3. At 'Select System' scroll to 'New System' and press **E/** .
4. At 'Select Sys Type' scroll to 'LT' and press **E/** .
5. At 'Confirm' press **E/** .
6. At 'Edit Name' press **E/** . See Entering Text.
7. Scroll to 'Edit Sys Options' and press **E/** .

Continue at 'Set Number Tag' below. Then see Edit Site Options. Then see Creating Groups. Then see Programming Frequencies/IDs.

To Edit Trunking Systems Options:

1. Press **MENU**.
2. At 'Program System' press **E/** .
3. At 'Select System' scroll to the system that you want to edit and press **E/** .
4. Scroll to 'Edit Sys Option' and press **E/** .
5. Scroll to the options below and press **E/** .
6. At 'Edit Name' press **E/** . See Entering Text.
7. Press **SCAN/SEARCH** to return to scanning when done with editing.

Note: Not all options will appear for EDACS SCAT and LTR systems.

Set Number Tag	Set Status Bit (Motorola only)	Rvw ID:Srch L/O (no EDACS SCAT)
ID Scan/Search (no EDACS SCAT)	Set End Code (Motorola only)	Clr All L/O IDs (no EDACS SCAT)
Set Delay Time	Edit Fleetmap (Motorola Type I/II only)	Set Audio AGC
	Emergency Alert (Moto/EDACS W/N only)	

Edit Fleetmap (Motorola Type I/II only)



Priority ID Scan (no EDACS SCAT/P25-1Tr)

Set ID Format (no EDACS SCAT)



Set Record

P25 NAC Option (P25-1Tr only)

Set Number Tag allows you to number a system. The default setting is no number tag (blank). See also Using Number Tags.



1. Scroll to 'Set Number Tag' and press **E/** .
2. Enter the number tag (**0-999**) (Press **.No** to clear the display) and press **E/**  to save and exit.

ID Scan/Search (no EDACS SCAT) sets whether the scanner scans the programmed ID groups (ID Scan) or searches for all IDs (ID Search) in a trunking system. The default setting is ID search.







1. Scroll to 'ID Scan/Search' and press **E/** .
2. Scroll to 'ID Scan' or 'ID Search' and press **E/**  to save and exit.

Note: You can also toggle this while scanning each trunked system by pressing  then SCAN/SEARCH.

Set Delay Time sets the delay (in seconds) the amount of time the scanner stays on a channel after the transmission has ended before moving to the next channel. A negative delay will force a resume after that number of seconds. This setting applies to all channels in the system. You cannot set the delay on a 'per channel' basis. The default setting is 2 seconds.

1. Scroll to 'Set Delay Time' and press **E/** .
2. Scroll to the desired delay time (-10, -5, -2, 0, 1, 2, 5, 10, or 30 secs.) and press **E/**  to save and exit.

Edit Fleetmap (Motorola Type I/II systems only) allows you to select a preprogrammed fleetmap or program a fleetmap for Motorola Type I systems. You must program a system fleet map in order for the scanner to properly track and display talkgroup ID's.

1. Scroll to 'Edit Fleetmap' and press **E/** .
2. To select a Preset Fleetmap, scroll to 'Preset' and press **E/** .
3. Scroll to the number of the preset fleetmap and press **E/**  to save and exit. See Preset Fleetmaps.
4. To program a Custom Fleetmap, scroll to 'Custom' and press **E/** .
5. At 'Block 0' scroll to the size code (0-14) and press **E/**  See Size Codes.
6. The scanner will prompt you to the next available block so you can scroll to and enter the next size code (0-14) then press **E/** .
7. The scanner will prompt you to the next available block so you can scroll to and enter the next size code (0-14) then press **E/** .
8. Repeat for each block as needed (0-7) and you will return to the 'Edit Sys Option' menu.



Note: If you select size code 12, 13, or 14, these restrictions apply:

- 12 can only be assigned to Blocks 0, 2, 4 or 6.
- 13 can only be assigned to Blocks 0 and 4.
- 14 can only be assigned to Block 0.



Since these size codes require multiple blocks, you will be prompted for the next available block. For example, if you assign Block 0 as 12, the scanner prompts you for block 2, the next block

available, instead of block 1. If you assign Block 0 as 14, you would not see another prompt because 14 uses all available blocks.

Priority ID Scan (no EDACS SCAT/P25-1Tr) allows you to use Priority Scan with IDs.

1. Scroll to 'Priority ID Scan' and press **E/** .
2. Scroll to 'On' or 'Off' and press **E/** .



Set Status Bit (Motorola only) sets how your scanner works with status bits (also called S-bits), letting you control how the scanner interprets and displays Motorola talkgroup IDs. The default setting is ignore.

1. Scroll to 'Set Status Bit' and press **E/** .
2. Scroll to one of two settings and press **E/**  to save and exit.

Yes - the scanner treats all received ID's as unique ID's.

Ignore - the scanner rounds all received ID's down to the next interval of 16.

Set End Code (Motorola only) sets how the scanner handles the transmission end code sent by most Motorola systems.







1. Scroll to 'Set End Code' and press **E/** .
2. Scroll to one of three settings and press **E/** .

Analog - The scanner recognizes only analog end transmission codes.



Analog+Digital - The scanner recognizes both analog and digital end codes.

Ignore - The scanner waits for the carrier to drop before leaving a channel.



Emergency Alert (Motorola/EDACS only) sets how your scanner handles IDs that have the emergency flag set. The default setting is off.

1. Scroll to 'Emergency Alert' and press **E/** .
2. Scroll to 'Set Alert Tone' and press **E/** .
3. At 'Set Tone' scroll to the alert (Alert 1-9 or Off) and press **E/** .
4. At 'Set Level' scroll to 'Level 1-15 or Auto' (the scanner sets the alert beep to the master volume level) and press **E/** .
5. Scroll to 'Set Alert Light' and press **E/** .
6. Scroll to Off, Blue, Red, Magenta, Green, Cyan, Yellow, or White and press **E/** .
7. At 'Set Pattern' scroll to On, Slow Blink, or Fast Blink and press **E/** .
8. Press **MENU** to return.

Set ID Format (DEC/HEX for Motorola or AFS/DEC for EDACS) sets the ID format for the system.

1. Scroll to 'Set ID Format' and press **E/** .
2. (Motorola) Scroll to 'Decimal Format' or 'Hex Format' and press **E/**  to save and exit.
3. (EDACS) Scroll to 'AFS Format' or 'Decimal Format' and press **E/** to save and exit.

Set Record enables the REC jack for all channels or marked channels in the system or off.



1. Scroll to 'Set Record' and press **E/** .
2. Scroll to one of 3 settings and press **E/**  to save and exit.

All Channel - The scanner sends the audio for all channels in the system to the REC jack, regardless of the channel's record option setting.



Marked Channel - The scanner only sends the audio for channels that have the record option turned on to the REC jack.

Off - The scanner does not send any audio from any channel in the system to the REC jack, even if the record option is turned on for a channel.



Rvw ID:Srch L/O (no EDACS SCAT) allows you to review locked out IDs in a system and unlock them.

1. Scroll to 'Rvw ID:Srch L/O' and press **E/** .
2. At 'Unlock?' scroll to the ID and press **E/**  to unlock.
3. 'Nothing Locked' appears if nothing is locked out.
4. Press **MENU** to return.



Clr All L/O IDs (no EDACS SCAT) allows you to unlock all the locked IDs in a system.

1. Scroll to 'Clr All L/O IDs' and press **E/** .
2. At 'Confirm?' press **E/**  to save and exit.
3. 'Nothing Locked' appears if nothing is locked out.
4. Press **MENU** to return.

Set Audio AGC allows you to turn the AGC feature on or off for the system. See also Adjust Audio AGC.

1. Scroll to 'Set Audio AGC' and press **E/** .
2. At 'Confirm?' press **E/**  to save and exit.
3. 'Nothing Locked' appears if nothing is locked out.
4. Press **MENU** to return.

P25 NAC Option (P25-1Tr only) allows you to have the scanner search for NAC codes or you can program a specific code for the system.



1. Scroll to 'P25 NAC Option' and press **E/** .
2. Scroll to one of two settings and press **E/** .

Search - The scanner opens squelch for any digital signal and displays the NAC being used.

Set P25 NAC - The scanner opens squelch only for signals that include the programmed NAC.

3. At 'Input P25 NAC' see Entering Text.





To Edit the System Name:

1. Press **MENU**.
2. At 'Program System' **E/** .
3. At 'Select System' scroll to the system you want to copy and press **E/** .
4. Scroll to 'Copy System' and press **E/** .
5. At 'New Sys Name?' see Entering Text to name the new system.

Copying a system will copy all sites, groups, channels, and settings including quick key assignments.

To Delete a System:





1. Press **MENU**.

2. At 'Program System' press **E/** .
3. At 'Select System' scroll to the system and press **E/** .
4. Scroll to 'Delete System' and press **E/** .
5. At 'Confirm Delete' press **E/** .

CREATING SITES (SITE AUTOMATICALLY CREATED FOR EDACS SCAT)







Once you have your trunking Systems Created and Systems Options configured you can create your sites. All trunked systems need at least one site to enter trunking frequencies.

To Create a Site:

1. Press **MENU**.
2. At 'Program System' press **E/** .
3. At 'Select System' scroll to the system where you want to create a site and press **E/** .
4. Scroll to 'Edit Site' and press **E/** .
5. At 'Select Site' scroll to 'New Site' and press **E/** .

Continue at 'Edit Name' below. Then see Creating Groups. Then see Programming Frequencies/IDs.

To Edit Site Options:

1. Press **MENU**.
2. At 'Program System' press **E/** .
3. At 'Select System' scroll to the system that has the site you want to edit and press **E/** .
4. Scroll to 'Edit Site' and press **E/** .
5. At 'Select Site' scroll to the site you want to edit and press **E/** .
6. Scroll to the options below and press **E/** .
7. Press **SCAN/SEARCH** to return to scanning when done with editing **E/** .



Note: Press **SCAN/SEARCH** to return to scanning when done with editing.

Edit Name (no EDACS SCAT)	Set Frequencies	Set Modulation (no P25-1TR)	Set Location Info
Set Quick Key	Edit Frequency	Set Attenuator	P25 Waiting Time (Motorola only)
Set Start-up Key	Set Lockout	Set Lockout	Delete Site
Edit Band Plan (Motorola Custom/ P25/VHF/UHF only)	Delete Frequency	Set Hold Time	New Site
Set Site Type (EDACS only)	New Frequency		

Edit Name (no EDACS SCAT) assigns a name to the site.



1. Scroll to 'Edit Name' and press **E/** . See Entering Text.

Set Quick Key assigns quick key to a site and will be scanned when the key is turned on. The default setting is no quick key.

1. Scroll to 'Set Quick Key' and press **E/** .
2. Scroll to the quick key number (**0-99** or **.No** for no quick key) you want assigned to the site and press **E/**  to save and exit.





Note: Pressing the first number of a 2-digit quick key will get you closer, 1 for 10, 2 for 20, etc. then scroll to second digit.

Set Start-up Key allows you to turn on the scanner with the site enabled for scan using the Startup Configuration. The default setting is no startup key.

1. Scroll to 'Set Startup Key' and press **E/** .
2. Scroll to (or enter) the startup key number (**0-9** or **.No** for no startup key) you want assigned to the site and press **E/**  to save and exit.

Edit Band Plan (Motorola Custom/P25/VHF/UHF only) band plans are required so the scanner can correctly determine the voice channel frequencies.



For P25 Systems there are two types of P25 systems: Explicit mode and Implicit mode channel assignment. Explicit mode systems include all information needed to determine voice frequencies on the control channel. For Explicit mode systems, leave all entries blank. The system will automatically detect the band plan and fill in the entries. You must supply the system's band plan for Implicit systems for the scanner to correctly determine voice frequencies.

1. Scroll to 'Edit Band Plan' and press **E/** .
2. At 'Select Plan' scroll to 'Band Plan 0-9, A-F' and press **E/** .
3. At 'Input Base Freq' enter the base frequency press **E/** .
4. Repeat for each band plan as needed **E/** .
5. Press **MENU** to return.

For Standard Motorola 800/900/Splinter Systems





Splinter - analog 800Mhz systems with frequencies between 866-869 MHz.





Rebanded - 851-854 MHz ending with 0 instead of 5 e.g. 852.1250, not 852.1375.

1. Scroll to 'Edit Band Plan' and press **E/** .
2. Scroll to '800/900 Standard' or '800Splinter' and press **E/** .
3. The scanner will use the regular old Motorola band plan and return to the menu.

For Custom (rebanded) Motorola/VHF/UHF Systems this allows you to create a custom band plan for rebanded/VHF/UHF systems. Custom band plans require that you enter both a lower and an upper base frequency value. The lower base frequency (or base) is always the base frequency as provided in the Radio Reference Database.

Use this Excel spreadsheet to calculate the upper base frequency value. The upper base frequency can also be found using the Band Plan Calculator at the online Wiki.



1. Scroll to 'Edit Band Plan' and press **E/** .
2. At 'Select Plan' scroll to 'Band Plan 1-6' and press **E/** .
3. At 'Set Base Freq' press **E/** .
4. At 'Input Lower' enter the lower base frequency and press **E/** .
5. At 'Input Upper' enter the upper base frequency and press **E/** .

6. Scroll to 'Set Offset' and press **E/** .
7. At 'Input Offset' enter the offset and press **E/** .
8. At 'Select Polarity' scroll to + or - and press **E/** .
9. Scroll to 'Set Spacing' and press **E/** .
10. Scroll to the step size and press **E/** .
11. Press **MENU** to return and repeat for each band plan as needed.
12. Press **MENU** to return.

For Standard Motorola 800 MHz rebanded systems you need to set Band Plan 1 and Band Plan 2 as follows:



Band Plan	Lower Base Freq	Upper Base Freq	Offset	Polarity	Spacing
1	851.025	854.000	440	+	25 kHz
2	851.0125	868.9875	0	+	25 kHz

Set Site Type (EDACS only) this is where you select a Wideband or Narrowband EDACS site.



1. Scroll to 'Set Site Type' and press **E/** .
2. Scroll to 'Wide (Standard)' or 'Narrow' and press **E/**  to save and exit.

Note: EDACS Wide is the same as EDACS Standard and use a 9600 baud control channel. EDACS Narrow-band sites use a 4800 baud control channel.





Set Frequencies this is where you program or change the trunking frequencies, delete frequencies, or lock them out.

1. To Program New Frequencies, scroll to 'Set Frequencies' and press **E/** .
2. At 'Set Frequency' scroll to 'New Frequency' and press **E/** .
3. At 'Input Frequency' enter the frequency and press **E/** .







For EDACS and LTR sites only:

1. At 'Input LCN' enter the LCN number and press **E/** .
2. Scroll to 'New Frequency' and press **E/**  to enter more frequencies.
3. Press **MENU** twice to return to the 'Edit Site' menu.



To Edit Frequencies:

1. Scroll to 'Set Frequencies' and press **E/** .
2. At 'Set Frequency' scroll to the frequency you want to edit and press **E/** .
3. Scroll to 'Edit Frequency' press **E/** . Edit the frequency and press **E/**  to save and exit.

For EDACS and LTR sites only:



1. At 'Input LCN' enter the LCN number and press **E/** .
2. Scroll to 'Set Lockout' press **E/** .
3. Set the lockout status and press **E/**  to save and exit **E/**  to save and exit.
4. Scroll to 'Delete Frequency' press **E/** . At 'Confirm Delete' press **E/** .
5. You will return to the 'Edit Site' menu.
6. Press **MENU** twice to return to the site menu.

Set Modulation this setting selects the modulation used for the site. The default setting is auto (NFM for FM frequencies). See also Band Defaults.

1. Scroll to 'Set Modulation' and press **E/** .
2. Scroll to Auto, NFM, or FM and press **E/**  to save and exit.



Note: You can also toggle modulation for a site in scan hold mode by pressing  then 9(MOD).

Set Attenuator this This setting controls whether the scanner attenuates signals on this site by about 20 dB. The default setting is off.

1. Scroll to 'Set Attenuator' and press **E/** .
2. Scroll to On or Off and press **E/**  to save and exit.



Note: You can also toggle attenuation for a site in scan hold mode by pressing  then 7(ATT).

Set Lockout determines whether a site will be scanned or not (even if the quick key for the site is turned on). 'Temporary L/O' means until you cycle power. The default setting is unlocked.









1. Scroll to 'Set Lockout' and press **E/** .
2. Scroll to 'Unlocked', 'Temporary L/O', or 'Lockout' and press **E/**  to save and exit.

Note: You can also toggle lockout by holding on the site and quickly pressing  then L/O.

Set Hold Time sets (in seconds) the amount of time the scanner will scan the site before moving on to the next site. If you select 0 for trunking sites, the scanner stays on the site for at least 1 second. The scanner moves to the next site after the hold time expires, any current transmission ends, and the channel delay time expires. The default setting is 0 seconds for each site.

1. Scroll to 'Set Hold Time' and press **E/** .
2. Enter the hold time (0-255 seconds) you desire and press **E/**  to save and exit.

Set Location Info allows you program a location for the site so the scanner will enable/disable it for scanning with a GPS unit attached. See Set GPS Format first to set your units, time zone, etc.

1. Scroll to 'Set Location Info' and press **E/** .
2. At 'Set Latitude' press **E/** . Enter the latitude and press **E/** .
3. At 'Set Longitude' **E/** . Enter the longitude and press **E/** .
4. At 'Set Range' press **E/** .
5. Enter the range (0.5 to 125 in 0.5 steps) and press **E/** .
6. At 'Set GPS Enable' press **E/** .
7. Scroll to On or Off and press **E/** .
8. Press **MENU** to return.

P25 Waiting Time (Motorola only) this setting basically gives the scanner time to determine if channels on Motorola analog mixed systems (not P25 only) have digital or analog transmissions. During this time, the scanner will evaluate the received signal and, if it detects P25 data, will open squelch immediately. If P25 is not detected before the delay expires, the scanner will open squelch at the end of this delay. This is to prevent "false decode" problems (digital noise at the beginning of transmissions). The default setting is 400 ms. This setting only affects Motorola channels with an Audio Type set to 'All'.

1. Scroll to 'P25 Wait Time' and press **E/** .





2. Set the Wait Time from 0 to 1000 ms and press **E/** .

Note: *Any analog transmissions will lose the first part of the transmission, up to the wait time you set here.*

CREATING GROUPS





Once you have your Systems built, systems options configured, (trunking system) Sites Created, and Site Options configured, you can create your groups.

To Create a New Group (no EDACS SCAT):

1. Press **MENU**.
2. At 'Program System' press **E/** .
3. At 'Select System' scroll to the system where you want to create a group and press **E/** .
4. Scroll to 'Edit Group' and press **E/** .
5. At 'Select Group' scroll to 'New Group' and press **E/** .

Continue at 'Edit Name' below. Then see Programming Frequencies/IDs.

To Edit Group Options:



1. Press **MENU**.
2. At 'Program System' press **E/** .
3. At 'Select System' scroll to the system where you want to edit a group and press **E/** .
4. Scroll to 'Edit Group' and press **E/** .
5. At 'Select Group' scroll to the group you want to edit and press **E/** .
6. Scroll to the options below and press **E/** .
7. Press **SCAN/SEARCH** to return to scanning when done with editing.

Edit Name	Set Location Info	Delete Group
Set Quick Key	Set Lockout	New Group
Edit Channel		

Edit Name allows you to change the name of a group.



1. Scroll to 'Edit Name' press **E/** . See Entering Text.





Set Quick Key sets the quick key for the group. The default setting is no quick key

1. Scroll to 'Set Quick Key' and press **E/** .
2. Scroll to or enter the quick key number (0-9 or .No for no quick key) you want to assign to the group and press **E/**  to save and exit.



Edit Channel creates channels and edits channel options. See Programming Frequencies/IDs.

Set Location Info allows you program a location for the group so the scanner will enable/disable it for scanning with a GPS unit attached. See Set GPS Format first to set your units, time zone, etc.

1. Scroll to 'Set Location Info' and press **E/** .
2. At 'Set Latitude' press **E/** . Enter the latitude and press **E/** .

3. At 'Set Longitude' press **E/** . Enter the longitude and press **E/** .
4. At 'Set Range' press **E/** .
5. Enter the range (**0.5** to **125** in 0.5 steps) and press **E/** .
6. At 'Set GPS Enable' press **E/** .
7. Scroll to On or Off and press **E/** .
8. Press **MENU** to return.

Set Lockout determines whether a group will be scanned or not (even if the quick key for the group is turned on). 'Temporary L/O' means until you cycle power. The default setting is Unlocked.



1. Scroll to 'Set Lockout' and press **E/** .
2. Scroll to 'Unlocked', 'Temporary L/O', or 'Lockout' and press **E/** .
3. Press **SCAN/SEARCH** or **L/O** to exit.

PROGRAMMING FREQUENCIES/TGIDS

Once you have your Systems built, systems options configured, Sites Created (for trunking systems), Site Options configured, and Groups Created, you can (finally) program your channels.

QUICKLY STORING A CONVENTIONAL FREQUENCY

To Program a Frequency into a 'Quick Save Group' in a 'Quick Save System':



1. In scan mode press **HOLD** to hold on any channel.
2. Enter the frequency and press **E/** .
3. At 'Quick Freq Save?' press **E/** .

Note: If the frequency is already stored in the group, 'Frequency Exists Accept? (Y/N)' appears. Press .No to return.

The scanner will save the frequency in a (created) group called 'Qck Save Grp' in a (created) system called 'Qck Save Cnv Sys' (with no quick keys assigned) and you will be at the 'Edit Channel' menu to complete the settings for the new channel. If you don't want to edit the channel settings or are done editing the channel, press **L/O** to return to 'Hold' to enter another frequency or **SCAN** to exit.

Then see Edit Channel Options, Edit Group Options, and Edit Conventional Systems Options to customize the channel(s), group, and system.

To Program a Frequency into an Existing Group:

1. In scan mode press **HOLD** to hold on any channel.
2. Enter the frequency and press **E/** .
3. At 'Quick Freq Save?' press **.No**.
4. At 'Select System' scroll to the system where you want to store the frequency and press **E/** .
5. At 'Select Group' scroll to the group where you want to store the frequency and press **E/** .

Note: If the frequency is already stored in the group, 'Frequency Exists' Accept? (Y/N)' appears. Press .No to return.



After storing the frequency, you will be at the 'Edit Channel' menu to complete the settings for the new channel. If you don't want to edit the channel settings or are done editing the channel, press **L/O** to return to 'Hold' to enter another frequency or **SCAN** to exit.

QUICKLY STORING AN ID

Note: You have to program the trunking system and site first.

See Programming Trunking Systems.

To Program an ID into a 'Quick Save Group':



1. In scan mode Hold on any channel in the system you want to store the ID in.
2. Enter the ID (see Entering IDs) and press **E/** .
3. At 'Quick TGID Save?' press **E/** .

Note: If the ID is already stored in the group, 'TGID Exists Accept? (Y/N)' appears. Press **.No to return.**

The scanner stores the ID into a (created) channel group called 'Qck Save Grp' (with no quick key assigned) and you will be at the 'Edit Channel' menu to complete the settings for the new channel. If you don't want to edit the channel settings or are done editing the channel, press **L/O** to return to 'Hold' to enter another ID or Scan to exit.

Then see Edit Channel Options and Edit Group Options to customize the channel(s), and group.

To Program an ID into an Existing Group:









1. In scan mode Hold on any channel.
2. Enter the ID (see Entering IDs) and press **E/** .
3. At 'Quick TGID Save?' press **.No**.
4. At 'Select System' scroll to the system where you want to store the ID and press **E/** .
5. At 'Select Group' scroll to the group where you want to store the ID and press **E/** .

Note: If the ID is already stored in the group, 'TGID Exists Accept? (Y/N)' appears. Press **.No to return.**

After storing the ID, you will be at the 'Edit Channel' menu to complete the settings for the new channel. If you don't want to edit the channel settings or are done editing the channel, press **L/O** to return to 'Hold' to enter another ID or **SCAN** to exit.

MANUALLY PROGRAMMING CHANNEL FREQUENCIES/TGIDS

To Program a New Channel:

1. Press **MENU**.
2. At 'Program System' press **E/** .
3. At 'Select System' scroll to system where you want to program a channel and press **E/** .
4. Scroll to 'Edit Group' and press **E/** .
5. At 'Select Group' scroll to the group that you want to program the channel in and press **E/** .
6. Scroll to 'Edit Channel' and press **E/** .
7. At 'Select Channel' scroll to 'New Channel' and press **E/** .
8. At 'Input Frequency (or TGID)' enter the frequency or ID and press **E/** . See also Set ID Format.
9. To enter a Conventional Frequency enter the frequency and press **E/** .
10. To enter a Motorola Type II ID enter the ID and press **E/** .

11. To enter a Motorola Type I ID enter the fleet number, press **.No** once for a hyphen, then enter the subfleet and press **E/** .

Note: If you omit the subfleet (still need the hyphen), the scanner treats this field as a wildcard (will treat the subfleet as 1 ID and receive all IDs in the subfleet). You can also lock out this subfleet ID so you will not receive it.

To enter a Motorola I-Call ID:

1. Press **.No** once then enter the ID and press **E/** .

To enter a Motorola Wildcard (receive any) I-Call ID:



1. Press **.No** once then enter **0** and press **E/** .

Note: You can also lock out this wildcard ID so you will not receive I-Calls.

To enter an EDACS ID in AFS (default) format, enter the agency number:

1. Press **.No** once for a hyphen, then the fleet and subfleet and press **E/** .

Note: If you omit the fleet and/or subfleet (still need the hyphen), the scanner treats these fields as wildcards (will treat the fleet and/or subfleet as 1 ID and receive all IDs in the fleet and/or subfleet) You can also lock out this fleet and/or subfleet ID so you will not receive it.

2. To enter an EDACS ID in Decimal format, enter the ID and press **E/** .
3. To enter an EDACS I-Call ID, press **.No** once then enter the ID and press **E/** .
4. To enter an EDACS Wildcard (receive any) I-Call ID, press **.No** once then enter **0** and press **E/** .

Note: You can also lock out this wildcard ID so you will not receive I-Calls.

5. To enter a LTR ID, enter the area code (**0** or **1**) and press **.No** once, then enter the home repeater number (**01-20**) and press **.No** once, then the user ID (1-254) and press **E/** .

Note: If you omit the user ID (still need the hyphen), the scanner treats this field as a wildcard (will treat the home repeater as 1 ID). You can also lock out this home repeater ID so you will not receive it.

6. To enter a Unit ID (Radio ID), press **.No** once then enter the ID and press **E/** .

Note: To view unit IDs you have to turn the option on in the 'Settings' menu. Other channel attributes (alerts, etc.) will not be applied to Unit ID channels. To enter hexadecimal IDs see Entering Text.



Note: If the channel is already stored in the group, 'TGID or Frequency Exists Accept? (Y/N)' appears. Press **.No to return.**





7. Continue at Edit Name below.
8. Press **MENU** to return to 'Select Channel'.
9. Scroll to 'New Channel' and press **E/** .
10. Program the rest of the channels the same way.

EDIT CHANNEL OPTIONS MENU

Once you have your systems built, systems options configured, Groups Created, and your Channels Programmed, you can set your channel options.



To Edit Channel Options:

1. Press **MENU**.
2. At 'Program System' press **E/** .
3. At 'Select System' scroll to the system where the channel is and press **E/** .
4. Scroll to 'Edit Group' and press **E/** .



5. Scroll to the Group that has the channel you want to edit and press **E/** .
6. Scroll to 'Edit Channel' press **E/** .
7. At 'Select Channel' scroll to the channel you want to edit and press **E/** .
8. You can also press **E/**  when the channel is displayed in scan mode. (Press **.No** to cancel storing a CTCSS/DCS tone or NAC code if asked).
9. Scroll to the options below and press **E/** .
10. Press **SCAN/SEARCH** to return to scanning when done with editing.

Edit Name	Set Attenuator (conventional only)	Volume Offset
Edit Frequency or TGID	Set Priority	Copy/Paste Channel
Set Audio Type (conventional/ Motorola only)	Set Alert	Delete Channel
Set Number Tag	Set Record	New Channel
Set Modulation (conventional only)	Set Lockout	

Edit Name if you do not enter a channel name, the scanner displays the frequency for conventional systems or the talkgroup ID for trunked systems when it stops on a channel.



1. Scroll to 'Edit Name' and press **E/** . See Entering Text.
2. Press **E/**  to save and exit.

Edit Frequency or TGID. See also 'Entering IDs'.

1. Scroll to 'Edit Frequency or TGID' and press **E/** .
2. Enter the frequency or ID and press **E/**  to save and exit.

Set Audio Type (Conventional/Motorola only) choose 'Digital Only' or 'Analog Only' according to the signal type. Select 'All' if this channel might contain both digital and analog signals.

Notes: If you are sure the channel is analog, set the channel to 'Analog Only'. This will prevent the 'P25 Waiting Time' for the conventional system or Motorola site from losing the first part of the transmission up to the wait time you set there.

3. Scroll to 'Set Audio Type' and press **E/** .
4. Scroll to one of three options and press **E/** .

All - The scanner automatically determines whether the audio is analog or digital.

Digital Only - The scanner will receive the channel only if it is carrying APCO 25 digital audio.

5. At 'P25 NAC Option' (conventional only) scroll to 1 of 2 options and press **E/** .





Search - The scanner searches and displays any NAC tone with the transmission.

Set P25 NAC - Allows you to program a NAC code. See Entering Text.

Note: you can also store a (blinking) NAC code in when receiving a frequency in scan mode by pressing **E/ .**



Analog Only - The scanner will receive the channel only if it is carrying analog audio. See also Understanding CTCSS/DCS.

Conventional only:

1. At 'Set CTCSS/DCS' scroll to 1 of 5 options and press **E/** .
2. Off - any signal opens squelch.
 - Search** - The scanner searches and displays any CTCSS or DCS tone with the transmission.
 - CTCSS** - Enter or scroll to the desired CTCSS tone you want present with the signal. Press **E/**  to save and exit.
 - DCS** - enter or scroll to the desired DCS tone you want present with the signal. Press **E/**  to save and exit.
 - Set Lockout** - Scroll to 'CTCSS or DCS' and press **E/** .
3. Enter or scroll to the desired tone you want locked out.
4. Press **E/**  to save and exit.

Note: you can also store a (blinking) CTCSS/DCS tone in when receiving a frequency in scan mode by pressing **E/ .**

Set Number Tag allows you to number a channel. The default setting is no number tag (blank). See also Using Number Tags.



1. Scroll to 'Set Number Tag' and press **E/** .
2. Enter the number tag (**0-999**) (Press **.No** to clear the display) and press **E/**  to save and exit.

Set Modulation (Conventional only) this setting selects the modulation used for the channel. The default setting is Auto (NFM for FM channels).

1. Scroll to 'Set Modulation' and press **E/** .
2. Scroll to Auto, AM, NFM, FM, WFM, or WFM Broadcast and press **E/**  to save and exit.



Note: You can also toggle modulation for a conventional channel in scan hold mode by pressing  then 9(MOD).

Set Attenuator (Conventional only) this setting controls whether the scanner attenuates signals on The channel by about 20 dB. The default setting is Off.

1. Scroll to 'Set Attenuator' and press **E/** .
2. Scroll to On or Off and press **E/**  to save and exit.



Note: You can also toggle attenuation for a conventional channel in scan hold mode by pressing  then 7(ATT).





Set Priority this setting controls whether the scanner treats the channel as a priority channel while scanning. The default setting is off. See also Priority Scan/Priority ID Scan/Priority Plus Scan.

1. Scroll to 'Set Priority' and press **E/** .
2. Scroll to On or Off and press **E/**  to save and exit.



Note: To use Priority ID Scan you must also enable Priority ID Scan for each system.

Set Alert this setting controls when and how the scanner alerts you if the channel becomes active.



1. Scroll to 'Set Alert' and press **E/** .
2. Scroll to 'Set Alert Tone' and press **E/** .

3. At 'Set Tone' scroll to the alert (Alert 1-9 or Off) and press E/ .
4. At 'Set Level' scroll to 'Level 1-15 or Auto' (the scanner sets the alert beep to the master volume level) and press E/ .
5. Scroll to 'Set Alert Light' and press E/ .
6. Scroll to Off, Blue, Red, Magenta, Green, Cyan, Yellow, or White and press E/ .
7. At 'Set Pattern' scroll to On, Slow Blink, or Fast Blink and press E/ .
8. Press **MENU** to return.

Set Record enables the REC jack for the channel. The default setting is off. You must also set the system's record option to either 'All Channel' (which will record all channels regardless of the channel's record setting) or 'Marked Channel' (which only records the channels you've set to record).



1. Scroll to 'Set Record' and press E/ .
2. Scroll to On or Off and press E/  to save and exit.

Set Lockout determines whether a channel will be scanned or not. 'Temporary L/O' means until you cycle power. The default setting is Unlocked.

1. Scroll to 'Set Lockout' and press E/ .
2. Scroll to 'Unlocked', 'Temporary L/O', or 'Lockout' and press E/ .
3. Press **SCAN/SEARCH** or **L/O** to exit.







Note: You can also toggle lockout for a channel in scan mode by pressing L/O.

Volume Offset this setting allows you to adjust the volume offset for the channel.

1. Scroll to 'Volume Offset' and press E/ .
2. Scroll to -3, -2, -1, 0, +1, +2, or +3 and press E/  to save and exit.

Note: You can also toggle volume offset for a channel in scan hold mode by pressing  then 5(LVL).

Copy/Paste Channel the scanner can copy a channel (and all its settings) into a copy buffer to paste into the same system (in a different group) or a group in another system.

1. Scroll to 'Copy Channel' press E/  to save to the channel buffer.
2. To Paste the Channel, press **MENU** until 'Select System' appears.
3. Scroll to system where you want to paste the channel and press E/ .
4. Scroll to 'Edit Group' and press E/ .
5. At 'Select Group' scroll to the group where you want to paste the channel and press E/ .
6. Scroll to 'Edit Channel' press E/ .
7. At 'Select Channel' scroll to 'Paste Channel' and press E/ .
8. Press **SCAN/SEARCH** or **L/O** to exit to exit.

Note: You can only copy and paste from like systems - conventional to conventional or trunking to trunking.

USING THE BCD996P2 WITH A GPS

LOCATION-BASED SCANNING

You can connect the scanner to a compatible GPS device and set the scanner to automatically lock and unlock trunked sites and channel groups based on the location information and range settings you program for those sites/groups. This frees you from having to manually enable and disable sites/groups as you change location. The BCD996P2 uses the data, supplied by an (optional) attached GPS unit, that allows the radio to automatically unlock and lockout sites/groups based on latitude and longitude. It uses the (programmed) center of the site/group, and the (programmed) range - the radius of a circle around the latitude and longitude up to 125 miles from that center.

A good application of this feature would be to set the longitude and latitude for each multi-site system transmitter as usually you can receive at least a handful in any given location.

You can find the physical location of antennas using the databases available at Radio Reference or the FCC's Antenna Structure Registration site. Both sites list the latitude, longitude, and height of the antenna and both sites can map the exact location for you. Radio Reference is more user-friendly, so it's easier to find what you're looking for.

NON RADIO LOCATION-BASED GPS FEATURES

When connected to a GPS, you can program specific location information which will trigger an alert from the scanner. The scanner becomes an extension of the GPS device. Even if you don't use the scanner to scan, you can enhance your GPS unit with information the scanner provides. The scanner also allows you to program audio and/or visual alerts for a:

Point of Interest (POI): Stores location and range. If you approach the set location, the radio sounds an alert up to 4 miles/km from the center.

Dangerous Road/Dangerous Crossing: Stores location, direction of travel, and speed. If you are traveling at a speed greater than that specified, in the direction specified, and if you are within range of the set location, the scanner sounds an alert at 1, .5, and .1 miles/km from the point. These range distances are also automatic and fixed.

You can also temporarily lockout (cancel) any combination of these alerts.

CONNECTING YOUR SCANNER

The GPS device must have a serial (RS-232) output, and be capable of outputting standard NMEA-0183 v3.01 compliant location data, and GGA/RMC data sentences at 4800 bps. Make sure that the cable terminates in a female, 9-pin serial connector and you select the correct baud rate (4800 bps) for the rear serial port.

The scanner will display 'Searching for Satellite' in GPS Display Mode until it receives the signal from the satellite if you have your connections and baud rate set correctly. The first time the scanner starts receiving a signal from the GPS, it beeps and briefly displays 'GPS Connected' and (temporary) locks and unlocks all sites and groups that are 'enabled for scan', unlocked, and whose quick key is enabled according to your current location. If you have a lot of data programmed, it might take the scanner a couple of minutes to complete the process. Once the scanner completes the initial GPS review, if you move into or out of an area covered by a site/group, the scanner beeps and displays the name of the site/group and whether it is being locked or unlocked.

If you cycle power, all sites/groups (enabled for scan) are unlocked until the scanner reacquires the GPS signal and completes the initial GPS review.

When the scanner does not receive GPS data, the scanner displays “No GPS Input”
See also Set GPS Format in the ‘Settings’ menu to set relevant options for GPS display modes.



To Program a Current Location (when connected to a GPS):

1. Press and hold **GPS** for 2 seconds.
2. The scanner opens a dialog (‘Storing Location’) to store your current location (or ‘Location Exists’, Accept?).
3. Scroll to ‘POI’, ‘Dangerous Xing’, or ‘Dangerous Road’ to select the type then press **E/** .

The default name is P (POI), X (dangerous crossing), R (dangerous road), then YYMMDD hhmmss that indicates the year, month, date, and time you stored the location point. ‘Road’, ‘Xing’, or ‘POI’ Stored and the default name with the position will briefly appear.





Continue at ‘Edit Name’ below.

To Program a New Location:

1. Press **MENU**.
2. Scroll to ‘Program Location’ and press **E/** .
3. At ‘Select Type’ scroll to ‘POI’, ‘Dangerous Xing’, or ‘Dangerous Road’ and press **E/** .
4. Scroll to ‘New Location’ and press **E/** .

The default name is DRD (dangerous road), DXG (dangerous crossing), or POI (point of interest).
Continue at ‘Edit Name’ below.

To Edit an Existing Location:

1. Press **MENU**.
2. Scroll to ‘Program Location’ and press **E/** .
3. At ‘Select Type’ scroll to ‘POI’, ‘Dangerous Xing’, or ‘Dangerous Road’ and press **E/** .
4. At ‘Select ‘POI’, ‘Dangerous Xing’, or ‘Dangerous Road’ scroll to the location you want to edit and press **E/** .
5. Scroll to the options below and press **E/** .
6. Press **SCAN/SEARCH** to return to scanning when done with editing.

POI

Edit Name

Set Type

Set Alert

Set Location Info

Set Range

Set Lockout

Delete Location

New Location

Dangerous Xing or Dangerous Road

Edit Name

Set Type

Set Alert Volume

Set Alert Light

Set Location Info

Set Heading

Set Speed Limit

Set Lockout

Delete Location

New Location



GPS DISPLAY MODE

GPS Review Location Mode







Edit Name the default name is P (POI), X (dangerous crossing), R (dangerous road), then YYMMDD hhmms that indicates the year, month, date, and time you stored the location point with a GPS.

1. Scroll to 'Edit Name' and press **E/** . See Entering Text.



Set Type if you want to change the location type, the scanner resets the available options based on the new location type and the scanner goes back to the 'Program Location' menu for that location.

1. Scroll to 'Set Type' and press **E/** .
2. At 'Select Type' scroll to 'POI', 'Dangerous Xing', or 'Dangerous Road' and press **E/**  to save and exit.

Set Alert (POI only) lets you configure the alert tone and/or light when you are in range of a POI. The default tone is 'Alert 1', the default level is 'Auto', the default color is 'Cyan' and default pattern is 'Fast Blink'.

1. Scroll to 'Set Alert' and press **E/** .
2. Scroll to 'Set Alert Tone' and press **E/** .
3. At 'Set Tone' scroll to the alert (Alert 1-4 or Off) and press **E/** .
4. At 'Set Level' scroll to 'Level 1-15 or Auto' (the scanner sets the alert beep to the master volume level) and press **E/** .
5. Scroll to 'Set Alert Light' and press **E/** .
6. Scroll to Off, Blue, Red, Magenta, Green, Cyan, Yellow, or White and press **E/** .
7. At 'Set Pattern' scroll to On, Slow Blink, or Fast Blink and press **E/** .
8. Press **MENU** to return.

Set Alert Light (Dangerous Road/Xing only) lets you configure the alert light when you approach a location'. The default color is 'Cyan' and default pattern is 'Fast Blink'.

1. Scroll to 'Set Alert Light' and press **E/** .
2. At 'Set Color' scroll to Off, Blue, Red, Magenta, Green, Cyan, Yellow, or White and press **E/** .
3. At 'Set Pattern' scroll to On, Slow Blink, or Fast Blink and press **E/** .
4. Press **MENU** to return.

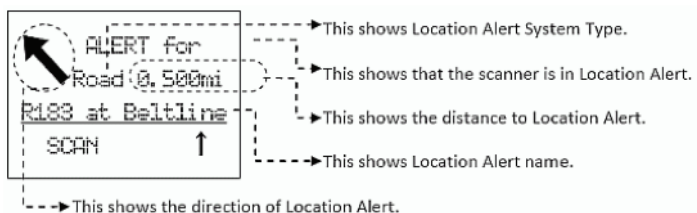



Alert in Scan Mode

There are three ranges for each Dangerous Xing or Dangerous Road alert: 1 mile/km, .5 mile/km and .1 mile/km.

The scanner alerts once for each range when it meets both of the following two conditions:

1. The first condition is heading for the Location. A valid heading is within $\pm 45^\circ$ of the value set in Set Heading.
2. The second condition is speed. It meets this condition when the current speed exceeds the speed that is set in Set Speed Limit.

When a second alert with a higher priority occurs during the current alert, the current alert is canceled and the scanner alerts for the higher priority alert.

The priority order is as follows:

1. Dangerous Road
2. Dangerous Xing
3. Point of Interest.

Set Location Info enter the latitude and longitude for the location.

See Set GPS Format first to set your units, time zone, etc.

1. Scroll to 'Set LocationInfo' and press **E/** **OK**.
2. At 'Set Latitude' press **E/** **OK**. Enter the latitude and press **E/** **OK**.
3. At 'Set Longitude' press **E/** **OK**. Enter the longitude and press **E/** **OK**.

Set Range (POI only) enter how far out from this location you want the scanner to alert you. You can also configure the scanner to sound an alert tone and flash a light when you reach the radius entered here.

The default setting is '.1 mile'.

1. Scroll to 'Set Range' and press **OK**.
2. Enter a range from (.05 to 4 mi/km in .05 mi/km steps) and press **OK** to save and exit.

Set Heading (Dangerous Road/Xing only) sets how the scanner alerts you to the location based on how you approach it. To make the alert direction-dependent, select a direction of approach.

Select 'All Range' to be alerted regardless of your direction of approach.

The default setting is 'All Range'.

1. Scroll to 'Set Heading' and press **OK**.
2. Scroll to 'All Range, North, NE, East, SE, South, SW, West, or NW' and press **OK** to save and exit.

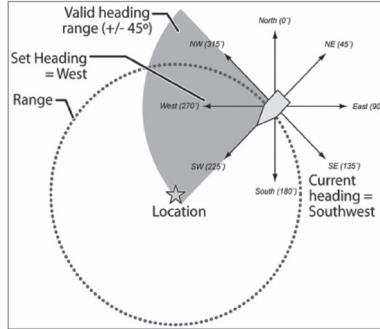

Set Speed Limit (Dangerous Road/Xing only) decides whether the scanner alerts you each time you approach the location or only when you are traveling above a certain speed. To make the alert speed-dependent, enter the speed limit for this location. Leave the speed limit blank to be alerted regardless of your speed. The default setting is '0 mile/h (0 km/h)'.

1. Scroll to 'Set Speed Limit' and press **OK**.
2. Enter a speed from 0 through 200 mi/km, in 1 mi/km steps and press **OK** to save and exit.

Set Lockout the default setting is 'Unlocked'.

1. Scroll to 'Set Lockout' and press **OK**.
2. Scroll to 'Unlocked', 'Temporary L/O', or 'Lockout' and press **OK** to save and exit.

Note: you can also do this in 'Review Location Mode' by pressing L/O.

GPS Display Mode (POI only)

Press GPS to switch to GPS display mode. In this mode, you can see the current location information as well as information about your position relative to selected POI's.

1. Rotating **OK** will select different POI's.
2. Press **OK** then **6(DISP)** to toggle the Display Modes.

	<p>The left side of the 1st line displays the current direction of travel.</p>
	<p>The right side of the 1st line displays the present time.</p>
	<p>The left side of the 2nd line displays the current speed.</p>
	<p>The right side of the 2nd line displays the elevation of the current location.</p>
	<p>The 3rd line is always "OFF" because a POI is not selected.</p>

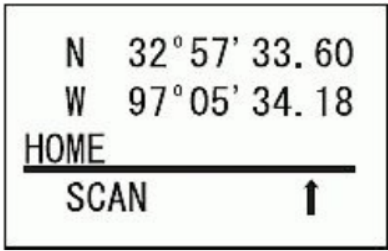
 <p style="text-align: center;">Location Display</p>	The 1st line displays the latitude of the current location.
	The 2nd line displays the longitude of the current location.
	The 3rd line displays "OFF" (when a POI is not selected) or the name of the selected POI.

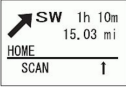
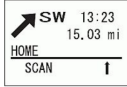
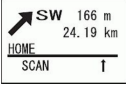
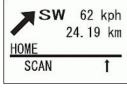
 <p style="text-align: center;">ETA Display</p>	 <p style="text-align: center;">Clock Display</p>	The large arrow shows the direction to the selected POI.
 <p style="text-align: center;">Elevation Display</p>	 <p style="text-align: center;">Speed Display</p>	The left side of the 1st line displays the current direction of travel.
		The 2nd line displays the distance to the selected POI.
		The 3rd line displays the name of the selected POI.

The right side of the 1st line displays:

- The ETA (Estimated Time for Arrival) to the selected POI.
- The present time.
- The elevation of the current location.
- The current speed.

While in GPS Display Mode

To Program the Current Location :

1. Press and hold **GPS** for 2 seconds.
2. To Select a POI turn the scroll control.
3. To Toggle through the POI Display Modes press  then **6(DISP)** (each time).

Note: If no programmed location is displayed ('OFF' in the display), you will only be able to toggle 'Data Display' and the (current) 'Location Display'.

To Temporarily Lock Out an Alert press **L/O** or turn . The scanner automatically unlocks the locked out location when it moves 4 miles or more from the alert point. Quickly pressing **L/O** press twice permanently locks out the alert and it will not be activated again if you should go near that alert point.

1. To Toggle 'Hold' mode on a background **SCAN/SEARCH** press **HOLD**.
2. To Return to Scan mode press **SCAN/SEARCH**.
3. Press **GPS** again to view GPS Display Mode.

4. To View 'Review Location' Mode press E/☐.

Notes: All sites/groups (with quick keys enabled and gps enabled for the site/group) not within range of your current location will be temporarily locked out. If you try to use a quick key to enable a site/group for scan that is out of range of your current location, you will see 'Location L/O' and then site/group name (only once), and it will temporary lock out the site/group.

If you disconnect/turn off your GPS unit, you will see 'No GPS Input' in GPS display mode and the scanner will return to scanning any sites/groups that the scanner did not temporary lock out. To restore all sites/groups, cycle the scanner off then on.

If you lose the satellite signal, you will see 'Searching for Satellite' until the GPS unit reacquires a signal.

If a GPS is detected as soon as the scanner is turned on, the scanner displays "GPS CONNECTED" instead of displaying individual lock/unlock messages for groups/sites. It applies the location-based rules to all systems at one time.

GPS REVIEW LOCATION MODE

If you have programmed data for a Point of Interest, Dangerous Crossing, and a Dangerous Road, you can review the type, range setting, and location information for each location.



Press GPS then E/Yes. The most recently stored location is displayed. Use the scroll control to display the next screen for review.

Note: the scanner will mute in this mode.

Important: while you are in Review Location Mode and press and hold GPS for 2 seconds, the data of the new point will overwrite the currently displayed data.

1. POI - Indicates a Point of Interest location.	5. Head - Indicates the selected heading to the designated Dangerous Crossing from any direction.
2. DXG - Indicates a Dangerous Crossing location.	6. Head - Indicates the selected heading to the designated Dangerous Road from a set direction.
3. DRD - Indicates a Dangerous Road location.	7. LS - Indicates the maximum Speed Limit you set.
4. Range - Indicates the programmed distance to your POI.	

While in Review Location Mode:

1. To Select a Location turn the scroll control.
2. To Return to 'GPS Display' Mode press **MENU**.
3. To Overwrite and Store the Current Location press and hold **GPS** for 2 seconds.
4. To Edit the Current Location press **E/** .
5. To Toggle the Lockout Status of the Location press L/O to toggle 'Temporary L/O, Locked Out, and Unlocked'.
6. To Unlock all Locations of the Current type (POI, DXG, or DRD) press and hold **L/O**.
7. To Unlock all Locations of All types press **E/**  then press and hold **L/O**.
8. To Return to Scan mode press **SCAN/SEARCH**.

PRIORITY/PRIORITY ID/PRIORITY PLUS SCAN

Priority Scan When the scanner is scanning a conventional system, it interrupts scanning (based on the priority check interval setting) to check priority channels for activity. The more channels you have set to priority, the longer the interruption will be. The scanner is unable to scan over 100 priority channels at once. The quick keys for the system(s) and group(s) containing the priority channel(s) have to be enabled (and unlocked) or the scanner will display 'Priority Scan No Channel'.

Priority Plus Scan the scanner only scans priority channels in (unlocked) conventional systems with system and group quick keys enabled.

The highest priority is for channels in system/site and group quick key 1. The lowest priority is for channels in system/site quick key 90 and group quick key 0. Priority for priority channels in the same channel group follows the order in which the channels were created.



Priority ID Scan this function is similar to conventional priority although there is no interruption during the transmission. Priority ID Scan is always on for a system if enabled in the system setting. Priority is checked in between transmissions, when the scanner is receiving the control channel, and during the channel delay period. The scanner can only look for priority IDs in the trunked system it is currently scanning.

Preemptive Priority preemptive priority is a feature that works on Motorola systems. If the Motorola system has priority channels, and you assign one of those TGs as priority in the scanner, then when one of those channels becomes active, the scanner will jump to it even if it is on a different system voice channel (i.e. it preempts your current reception). This feature relies on the system itself having talkgroups assigned as priority (so the active channel information is included on voice channel low-speed data). If a talkgroup you assign as priority is not also a priority channel on the transmitting system, then the scanner will use standard trunking priority for the talkgroup.

To Use Priority Scan you must first set your priority channels.

To Use Priority ID Scan you must also enable Priority ID Scan for each system.



To Edit Priority Scan Options:

1. Press **MENU**.
2. Scroll to 'Priority Scan' and press **E/** .
3. Scroll to the options below and press **E/** .
4. Press **SCAN/SEARCH** to return to scanning when done with editing.



Set Priority sets the priority mode. You can also toggle these modes by pressing **PRI** in scan mode.

1. Scroll to 1 of 3 options and press **E/** .
 - Off** - the priority feature is off.
 - On** - the scanner checks conventional priority channels, and priority IDs within systems that have priority ID enabled.
 - PRI** - appears in the display when you select this mode.
 - Plus On** - the scanner only scans the conventional priority channels.
 - PRI** - flashes in the display when you select this mode.

Set Interval sets how often the scanner will check the priority channels.

1. Scroll to 'Set Interval' and press **E/** .
2. Enter the number of seconds (1-10) and press **E/**  to save and exit.

MaxCHs/PRI-Scan sets the maximum priority channel numbers that are scanned during one priority scan interrupt. If there are more priority channels than the value you select, the channels are divided into more than one group and the scanner scans each group in turn. For example, if you set the maximum channels to 20 and there are 100 priority channels, the scanner checks those 100 channels in groups of 20 and takes a total of 5 intervals to complete the priority scan.

1. Scroll to 'MaxCHs/PRI-Scan' and press **E/** .
2. Enter the number of number of channels to check (1-100) and press **E/**  to save and exit.

USING STARTUP KEYS

You can program each of your Systems with a Startup Key (0-9) so that when you power up the scanner and press the key number at the same time, just those Favorites List(s) assigned to the key will be enabled for scan. Systems are not affected.

To Use a Startup Key:

1. Turn the scanner off.
2. Press & hold the number key that corresponds to the startup key when you turn the scanner on.
3. Continue holding the number key until the scanner display shows the number of the startup key configuration.

When you use startup configuration, the scanner checks all systems, sites, and search ranges and:

- All systems, sites, or search ranges that do not have a startup key assigned will be scanned the way they were when you last turned off the scanner.
- All systems, sites, or search ranges that have a the startup key assigned to the one you pressed will be unlocked.
- All systems, sites, or search ranges that have a different startup key assigned will be locked out.
- The scanner will remember the last startup configuration you used when you power up the scanner using just the power key.

Caution: If you press the wrong key when you press the power key to set your startup configuration, and that wrong key doesn't have any systems assigned to that key, you will startup your scanner with all systems locked out.

SCANNING SYSTEMS

With all previous scanners, you selected banks to scan that had channels stored in them. With this scanner, you select 'System Quick Keys' to scan that have 'Systems', 'Sites', or Custom/Service Searches assigned to them. So, now you turn 'System/Site/Search Quick Keys' on and off and 'Group Quick Keys' on and off (within each 'System' or 'Site'). Turning quick keys on and off for systems/groups/sites/searches is not the same as locking and unlocking systems/sites/searches. You can still do that separately (if you really want to confuse yourself). See also Using Quick Keys.

First, all (unlocked) systems/sites belonging to Quick Key 1 are scanned. Then systems/sites that belong to Quick Key 2, ..., 9, 0, 11, ..., 19, 10, 21, ..., 99, 90 are scanned in order. Systems/sites with the same quick key are scanned in order of creation. Systems/sites with no quick key are scanned last and in order of creation (including created 'Quick Save' systems).

Groups within the systems/sites are scanned with the same rules.

Conventional channels within the groups are scanned in order of creation.

IDs are not really scanned. The scanner checks for any activity in the trunking system and if any ID becomes active, the scanner will display it in 'ID Search' mode. In 'ID Scan' mode, the scanner will only display IDs programmed in to groups.

Then the scanner starts any (unlocked/enabled) service searches, searching them in the menu order. Then any (unlocked/enabled) custom searches from 1 to 10 in turn.

Then the scanner scans the system called 'Close Call'. This system is created if you do a Close Call 'Auto Store'. If the 'Close Call' system has no frequencies, the scanner does not scan the system.

Then the scanner scans the 'Close Call Hits' system (if you have unlocked it; locked out by default). This is a system that automatically stores the frequencies found by Close Call. If the 'Close Call Hits' system has no frequencies, the scanner does not scan the system.

Then the scanner starts all over.

Press **SCAN/SEARCH**. The scanner scans a system for the duration you set using the 'system hold time' option. For trunked systems, the scanner moves to the next system after the hold time expires, the current transmission ends, and the channel delay expires. Conventional systems operate similarly, but all (unlocked) channels are scanned at least one time regardless of the hold time setting.

Notes: If no systems are programmed, or all systems (or groups in a system) are locked out or turned off, 'Nothing to Scan' appears. Turn on a system/site quick key or unlock a system/site to scan. If you turn off all groups in a system you will not be able to turn any back on and also see 'Nothing to Scan'. In that case, while in Scan mode, press and hold Func (F) to lock function mode. Scroll to the system then press the number of the group quick key(s) you want to enable. Press F to start scanning then press F again to unlock function mode.

Any conventional system, Close Call system, trunked site, group, service search, custom search, or 'Quick Save' system/group not assigned to a quick key (and/or not locked out) will be scanned.

To continue scanning (move on to the next channel) Press **SCAN/SEARCH** or turn the scroll control (S).

To change the scan or search direction turn the scroll control backward or forward.

To toggle between ID Scan or ID Search Mode while scanning each trunked system, press S then **SCAN/SEARCH**.

To toggle between Display Modes 1, 2 or 3 Hold on any channel and press **6** then **6(DISP)**. Press Hold to resume.

To toggle System/Site/Search Quick Keys on or off for a Single Digit system/site/search, press the number key assigned to the system/site/search.

To turn a Double-Digit system/site/search on or off, press **.No** first then press the two number keys.

To toggle Group Quick Keys on or off in current system press **6** then the number key assigned to the group.

To toggle Group Quick Keys on or off in another system press and hold **6** to 'lock' Function mode. Scroll to the (enabled) system that contains the (enabled) group you want to turn on/off then press the corresponding number key(s). Press **6** twice to 'unlock' Function mode and resume.

To hold on a channel press **Hold**. To step through IDs/frequencies, turn the scroll control backward or forward. Press **Hold** to resume.

To hold on a specific frequency Hold on any channel in a conventional system. Enter the new frequency and press **Hold**. Press **SCAN/SEARCH** to exit.

To hold on a specific ID in the current site Hold on the site.

Enter the new ID (press **..** [2 dots] for a dash-EDACS AFS) and press **HOLD**. Press **HOLD** to resume.

To hold on any system/site/search press and hold **6** to 'lock' Function mode. Press **6** to 'unlock' Function mode to resume.

To edit the current channel press **E/6**.

To lock out a channel or frequency quickly press **L/O** once while the channel or frequency is in the display to temporary lock out.

Quickly press **L/O** twice to lock out.

To lock or unlock a group see Locking/Unlocking Groups.

To lock out a conventional system/trunked site/search while receiving the system/site/search quickly press **E/6** then **L/O** once to temporary lock out. Quickly press **L/O** twice to lock out.

To store a displayed ID into an Existing Group' (ID Search) press **E/6**.

At 'Quick TGID Save?' press **.No**. See also Storing a Displayed ID.

To store a displayed ID into 'Quick Save' Group' ID (ID Search) press **E/6**. At 'Quick TGID Save?' press **E/6**.

See also Storing a Displayed ID.

To store a (blinking) CTCSS or DCS tone (for a conventional channel set to analog only), press **E/6**. At 'Set Found CTCSS/DCS?' press **E/6**. Press **SCAN/SEARCH** to resume.

To store a (blinking) NAC code (for a conventional channel set to digital only), press **E/6**. At 'Set Found P25 NAC?' press **E/6**.

Press **SCAN/SEARCH** to resume.

To store a search frequency (Search with Scan) press **E/6**.

Then see Storing a Displayed Frequency.

To toggle the attenuation for a conventional channel on or off Hold on the channel and press **6** then **7(ATT)**. Press **HOLD** to resume.

To toggle the attenuation for a trunking site on or off Hold on the site and press **ATT** then **7(ATT)**. Press **HOLD** to resume.

To toggle the attenuation for a search on or off (Search with Scan) press **ATT** then **7(ATT)** while searching (or hold on the search first).

To toggle global attenuation Hold on any channel and press **ATT** then press and hold **7(ATT)**.

To toggle the modulation for a conventional channel or trunked site Hold on the channel/site and press **MOD** then **9(MOD)**. Press Hold to resume.

To toggle the modulation for a service/custom search press **MOD** then **9(MOD)** while searching (or hold first).

To toggle the volume offset for a conventional channel Hold on the channel and press **LVL** then **5(LVL)** to toggle the desired offset.

Press **HOLD** to resume.

To check for a repeater frequency on a conventional channel Hold on the channel. Press **REV** then press and hold **8(REV)**. Press **HOLD** to resume.

To toggle Intermediate Frequency Exchange for a conventional channel on or off Hold on the channel and press **IFX** then **4(IFX)**. Press **HOLD** to resume.

To toggle Priority Modes press **PRI** to toggle Priority on, Priority Plus on, or Off.

To toggle Weather Alert Priority on or off press **WX**.

To toggle Close Call Modes press **SQ** (**☎**).

To view and listen to a Close Call hit (CC Override Off) press **E/** **CC** to listen to and view the frequency (only if it's still there).

To go to a channel number tag in the current system/site Hold on the system. Enter the channel number tag and press **MENU**.

See also Using Number Tags.

To go to a channel number tag in a different system Hold on any channel.

Enter the system number tag, press **.No**, the channel number tag, then **MENU**.

To go to a system/search number tag, hold on any channel.

Enter the system/search number tag, press **.No**, then **MENU**.

To unlock a conventional channel see Locking/Unlocking Channels.

To unlock and/or review locked out IDs see Reviewing Locked out IDs.

To unlock all IDs see Clear All L/O IDs.

To unlock a conventional system/trunked site/search press and hold **L/O** to 'lock' function mode then scroll to the system/site/search and press **L/O** to unlock.

Press **L/O** twice to 'unlock' Function mode and resume.

See also Locking/Unlocking Systems/Sites/Searches.

To unlock search frequencies press **L/O** then **L/O** while searching.

Scroll to the frequency and press **E/** **L/O** to unlock.

To start Close Call Only press and hold **SQ** (**☎**). Press **SCAN/SEARCH** to exit.

To start Weather Scan press and hold **WX**. Press **SCAN/SEARCH** to exit.

To start Tone-Out Standby/Search press **L/O** then **SQ**.

Press **SCAN/SEARCH** to exit.

To view GPS Display Mode press **GPS**. Press **SCAN/SEARCH** to exit.

To view P25 Display Mode press **☐** then **Vol**. Press **☐** then **Vol** to exit.

To view Band Scope Mode Hold on any channel and press **☐** then **3(Srch 3)**. (set to Search Key 3 by default).

Storing a Displayed ID in ID Search Mode

1. To store a displayed ID into an existing group during ID Search, press **E/☐**.
2. You will see 'Quick TGID Save?' in the display then press **.No**.
3. At the 'Select Group' prompt, scroll to the group where you want to store the ID and press **E/☐**.
4. After storing the ID, you will be at the 'Edit Channel' menu to complete the settings for the new channel.
5. If you don't want to edit the channel settings or are done editing the channel, press **SCAN/SEARCH** to return to scanning.
6. To store a displayed ID into a 'Quick Save Group' during ID Search, press **E/☐**.
7. You will see 'Quick TGID Save?' in the display then press **E/☐** again.
8. The scanner stores the ID into a (created) channel group called 'Qck Save Grp' and you will be at the 'Edit Channel' menu to complete the settings for the new channel.
9. If you don't want to edit the channel settings or are done editing the channel, press **SCAN/SEARCH** to return to scanning.

Note: If the ID is already stored in the group, 'TGID Exists' Accept? (Y/N)' appears. Press .No to return to searching (or search hold) or E/☐ to go to the 'Edit Channel' menu.

USING NUMBER TAGS

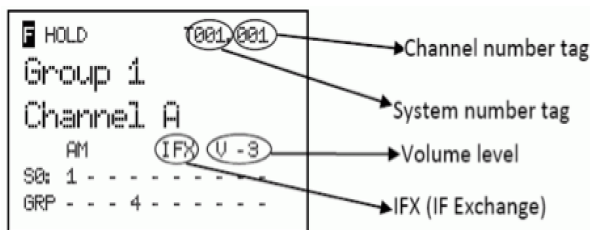

To View Number Tags for a Channel and/or System press **HOLD** to hold on the channel or system.

Press **☐** (or press and hold **☐** to view longer) to view the current system and channel number shown in the top left corner of the display as "T000. 000".

For example "T002. 043" would indicate the current system is 2 and the current channel is 43.

To Go to a Channel in the Current System Hold on the current system. Enter the channel number and press **MENU**. Press **HOLD** to resume.

To Go to a Channel in a Different System Hold on any system.

Enter the system number, press **.No**, then the channel number and press **MENU**. Press **HOLD** to resume.

To Go to a System or Custom/Service Search Hold on any system/search.

Enter the system/search number tag, press **.No**, and press **MENU**.

Press **HOLD** to resume.

Notes: Selecting just a system will hold on the first frequency in the system (not ID).

If two systems/searches have the same number tag, they will be selected in sequence (the first time you select the number tag, the scanner will go to the first system/search assigned to that number tag; if you select the same number tag again, it will go to the 2nd system/search assigned to that number tag, and so on). The same rule applies to channel number tags (so don't start at 1 for each channel group in the system).

OPTIMIZING P25 PERFORMANCE

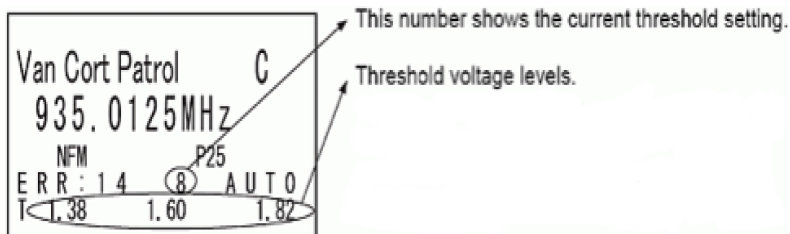

Press **⏏** then **VOL**. The next to last line on the display now shows the digital error rate and the AUTO decode threshold setting (0-20).

The last line on the display shows the decode threshold levels for the site.

Allow the scanner to monitor channel activity for several minutes. The error rate should drop for each transmission and the threshold levels should automatically adjust to a more optimal setting. This is the site's optimum decode threshold. Press **⏏** then **VOL** to exit.

See the following settings to make adjustments P25 Waiting Time, P25 LP Filter, P25 Adjust Mode, and P25 Adjust Level.

LOCKING/UNLOCKING SYSTEMS/SITES/SEARCHES

With the advent of Multi-site trunking, you can no longer lockout a trunking system. You have to lockout the site assigned to the system. You can still lockout conventional systems and searches the same way. Also, with the ability now to assign quick keys the searches you can turn them off and on or lockout/unlock them just like conventional systems and trunked sites.

Remember, unlocking or locking out a system/site/search is not the same thing as enabling/disabling it (turning the quick key on or off).

To Lock out a Conventional System/Trunked Site/Search in Scan Mode hold on any channel/frequency in the system/site/search, press **⏏** then **L/O** to toggle 'Unlocked', 'Temporary L/O', or 'Lockout'. Press **HOLD** to resume.

Note: 'Temporary Lockout' means unlocked the next time you cycle power the site/system/search will be unlocked.

Or, use Menu to drill down to the system/site/search options and lock it out there.

See 'Edit Conventional System Options', 'Edit Site Options', 'Edit Service Search', or 'Edit Custom Search'.

To Unlock a Conventional System/Trunked Site/Search in Scan Mode press and hold **☐** to 'lock' function mode.

Rotate the scroll control until the system/site/search you want to unlock appears. Press **L/O** (each time) to toggle 'Unlocked', 'Temporary L/O', or 'Lockout'. (You have to be quick to get 'Lockout'). Press **SCAN/SEARCH** to return.

Note: You will see 'Nothing to Scan' if the quick key is not turned on for the system/site/search (if one is assigned). Press SCAN/SEARCH to return to scanning.

Or, use **MENU** to drill down to the system/site/search options and unlock it there. See 'Edit Conventional System Options', 'Edit Site Options', 'Edit Service Search', or 'Edit Custom Search'.

To Unlock All Conventional Systems, Trunked Sites, Groups, Channels, and Searches in scan mode press **☐** then press and hold **L/O** until 'Unlock All Systems?' appears. Press **E/☐**.

LOCKING/UNLOCKING GROUPS

Remember, unlocking or locking out a group is not the same thing as enabling/disabling it (turning the quick key on or off).

To Lock out or Unlock a Group in Scan Mode press and hold **☐** to 'lock' function mode.

1. Rotate the scroll control until the system that has the group you want to lock or unlock appears. Press **MENU**.
2. Scroll to 'Edit Group' and press **E/☐**.
3. At 'Select Group' scroll to the group you want to lock or unlock and press **E/☐**.
4. Scroll to 'Set Lockout' and press **E/☐**.
5. Scroll to 'Unlocked', 'Temporary L/O', or 'Lockout' and press **E/☐**.
6. Press **SCAN/SEARCH** or **L/O** to exit.

Note: 'Temporary Lockout' means unlocked the next time you cycle power the group will be unlocked.

Or, use **MENU** to drill down to the group options and lock/unlock it there. See 'Edit Group Options'.

LOCKING/UNLOCKING CHANNELS

There are several ways to get to a channel. Some ways are quicker than others. Some ways you have to be quick with those keys, other ways you can take your time pressing them. Use what works best for you.

To Lock out a Channel while Scanning quickly press **L/O** when the channel appears in the display to toggle 'Unlocked', 'Temporary L/O', or 'Lockout'.

Note: 'Temporary Lockout' means unlocked the next time you cycle power the group will be unlocked.

1. Or, quickly press **HOLD** to hold on the channel. Press **L/O** to toggle 'Unlocked', 'Temporary L/O', or 'Lockout'.
2. Or, quickly press **E/☐** to go to the menu for that channel. (Press **.No** to cancel storing a tone code if asked).
3. Scroll to 'Set Lockout' and press **E/☐**.
4. Scroll to 'Unlocked', 'Temporary L/O', or 'Lockout' and press **E/☐**.

5. Or, use **MENU** to drill down to the channel options and lock it out there. See 'Edit Channel Options'.

To Unlock a Single Channel in Scan Mode press **HOLD** to hold on any channel.

Press **OK** and quickly (within 3 seconds) scroll to the system that has the channel you want to unlock then quickly (within 3 seconds) press **E/OK**.

Scroll to the channel you want to unlock and press **L/O** until 'Unlocked' is displayed.

Or, use **MENU** to drill down to the channel options and unlock it there. See 'Edit Channel Options'.

To Unlock All Channels in a Conventional System in Scan Mode:

1. Press **HOLD** to hold on any channel in the system.
2. Press and hold **L/O** until 'All Unlocked' appears.
3. Press **HOLD** or **SCAN/SEARCH** to resume scanning.

Note: This will also enable all your groups (turn the quick keys on).

To Review and/or Unlock Locked out IDs in a System:

1. Press **MENU**. At 'Program System' press **E/OK**.
2. At 'Select System' scroll to the system that has the ID(s) you want to unlock and press **E/OK**.
3. Scroll to 'Edit Sys Option' and press **E/OK**.
4. Scroll to 'Rvw ID:Srch L/O' and press **E/OK**.
5. At 'Unlock?' scroll to the ID and press **E/OK** to unlock.
6. 'Nothing Locked' appears if nothing is locked out.
7. Press **MENU** to return.

To Unlock All IDs in a System Scroll to 'Clr All L/O IDs' and press **E/OK**. At 'Confirm?' press **E/OK** to save and exit.

BAND SCOPE MODE

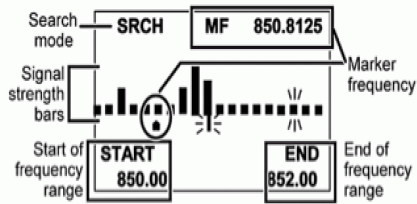

Search Mode with Normal Screen

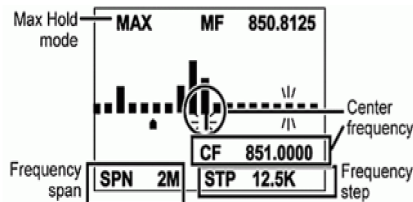

Max Hold Mode with Settings Screen

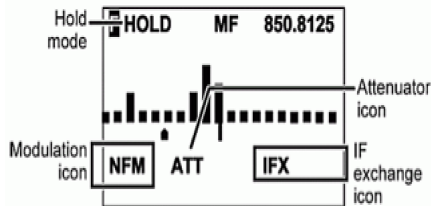

Hold Mode in Function Mode Screen

The Band Scope feature lets you have the scanner provide a visual representation of radio activity in a frequency band. The screen is arranged with the frequencies increasing in value from left-to-right, and a signal strength meter for signals. Band Scope Mode searches a frequency range and displays the signal level in real time. You can set the center frequency and span of the frequency range. In Hold Mode, you can monitor the displayed range.

The scanner rapidly sweeps between the endpoints of the selected frequency range and updates each bar segment with the relative signal strength in each pass. You can use the band scope in normal mode (the bars are all updated with the most recent signal strength) or 'Max Hold Mode' (the bars update only if there is a stronger signal than one previously stored for the current position).

This feature allows you to get a "picture" of spectrum activity across the selected range, identify intermittently active frequencies, check antenna performance, check coax quality, verify coverage areas, and identify interference.

USING BAND SCOPE MODE

To start Band Scope mode Hold on any channel and press **☐** then **3(Srch 3)** to start Band Scope mode at the frequency you held at. Band Scope mode is assigned to this Search Key (3) by default.

Search Mode - **'SRCH'** shows in the display and the scanner searches and displays the signals of the frequency range in real time. The frequency range is shown in 32 bars determined by the center frequency and span. While searching, the center frequency icon and the bar which shows the current frequency blink. The scanner starts from the lowest frequency of the frequency range and searches to the highest frequency of the frequency range. If the scanner finds a transmission, the scanner displays the strongest and most current signal level in the bar for each frequency in the range.

Max Hold Search Mode - **'MAX'** shows in the display and will freeze the signal strength bars at their strongest signals.

Hold Mode - **'HOLD'** shows in the display and allows you hold the sweep then scroll to and listen to a frequency.

To toggle between 'Search' mode and 'Max Hold Search' mode press **☐** then **SCAN/SEARCH**.

To listen to any frequency under the marker Hold (in either mode) and scroll to the frequency. To return the marker to the center frequency press **☐** then **L/O**. Press **HOLD** to return to the sweep.

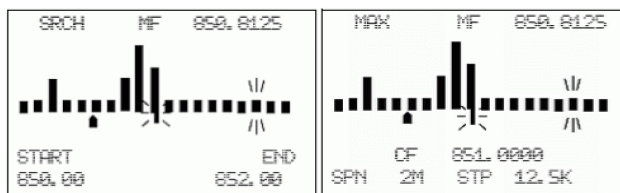

Normal screen - Displays the center frequency and start/end frequency of the range on the bottom lines.

To move the marker one frequency step turn **☐**. Pressing **☐** first will move the marker faster.

To reset the center frequency to the new frequency under the marker press **E/☐**.

To return the marker to the center frequency press **☐** then **L/O**.

To enter the Settings Screen press **.No**. This screen displays center frequency of the range, search step, and span of the range on the bottom lines for 10 seconds and the icon of the selected item blinks. Press **.No** again to move to the next parameter. To exit press **L/O** (or wait 10 seconds).

To change the center frequency press **.No** until **CF** is blinking then press **E/☐**.

At 'Edit Center Frequency' enter the new center frequency and press **E/☐** to save and exit. Press **L/O** to exit.

To change the span of the range press **.No** until **SPN** is blinking then use the scroll control to select .2-500 MHz. Press **L/O** to exit.

To change the search step press **.No** until **STP** is blinking then use the scroll control to select the step size from 5-100 kHz. Press **L/O** to exit.

To toggle the modulation press **☐** then **9(MOD)**.

To toggle Intermediate Frequency Exchange on or off Hold and press **4(IFX)**. Press **HOLD** to resume.

To toggle the attenuator on or off press **7(ATT)**. (Press and hold **7(ATT)** for global attenuation).

Note: the ATT icon only shows in Function mode.

Notes: The search time changes depending on the search step size. The step defaults to the default band step for the channel. 'Att' will not show in the display when on unless in Function mode. If you manually set the mode to NFM or FM, the scanner will not reliably

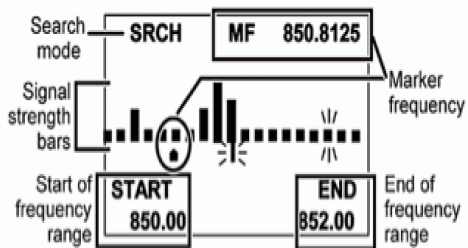

Search Mode with Normal Screen

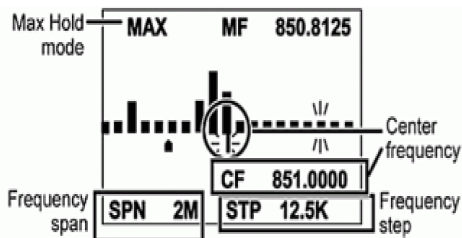

Max Hold Mode with Settings Screen

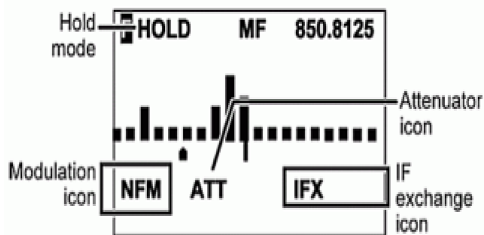



Hold Mode in Function Mode Screen

detect signals that are modulated in either FMB or WFM. Close Call, Priority ScClosean, Weather Scan and GPS functions do not work in Band Scope Mode.

SEARCH/CLOSE CALL OPTIONS MENU

These are the settings you should look at before you perform a quick search, close call search, search and store, or close call auto store.

To Edit Search and Close Options :

1. Press **MENU**.
2. Scroll to 'Srch/CloCall Opt' and press **E/** .
3. Scroll to the options below and press **E/** .
4. Press **SCAN/SEARCH** to return to scanning when done with editing.

Freq Lockouts

Max Auto Store

Set Record

Broadcast Screen

Set Delay Time

Set Audio AGC

Tone/Code Search

Set Attenuator



P25 Waiting Time

Repeater Find



Freq Lockouts allows you to review locked out frequencies or unlock all frequencies for Searching and Close Call search.

Note: You can also do this in search mode by pressing  then pressing and holding L/O.

Unlocking All Frequencies:

1. Scroll to 'Freq Lockouts' press **MENU**.
2. At 'Unlock All' press **E/** .
3. At 'Confirm?' press **E/**  to save and exit.
4. Press **MENU** to return.

Reviewing Locked Out Frequencies: A 'T' will appear to the right of a frequency if it is temporarily locked out.

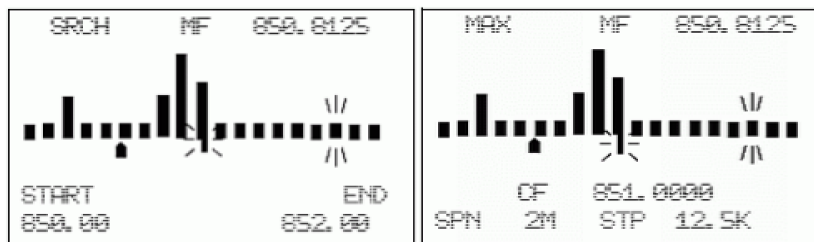

1. Scroll to 'Rvw Search L/O' and press **E/** . If no frequencies are locked out, you will see 'Nothing Locked'.
2. Scroll to the frequency (or press **.No** to go to the next) and press **E/**  to unlock.
3. Press **MENU** twice to return.





Note: You can also do this in search mode by pressing  then L/O.

Broadcast Screen these settings determine whether the scanner automatically ignores transmissions that are on common broadcasts, paging systems, and other annoyance radio sources during Custom Search, Quick Search, or Close Call Search.



Note: Broadcast screen is not effective during some service searches.

1. Scroll to 'Broadcast Screen' and press **E/** .
2. Scroll to 1 of 4 options and press **E/** 
 - Set All Bands On** - turns on broadcast screen on for all bands. Press **MENU** to return.
 - Set All Bands Off** - turns off broadcast screen off for all bands.
3. Press **MENU** to return.
 - Set Each Band** - then scroll to each band and press **E/**  to turn off or on.
4. Press **MENU** to return.
 - Pager** - the scanner skips known paging system frequencies.
 - FM** - the scanner skips known FM frequencies.
 - UHF TV** - the scanner skips known UHF TV frequencies.
 - VHF TV** - the scanner skips known VHF TV frequencies.
 - NOAA WX** - the scanner skips known NOAA weather frequencies.
 - Band 1-10** - the scanner skips known frequencies for custom broadcast ranges.



Program Band - Scroll to the custom band (1-10) and press **E/** .

1. At 'Set Lower Limit' enter the lower limit of the frequency range and press **E/** .
2. At 'Set Upper Limit' enter the upper limit of the frequency range and press **E/** .
3. Scroll to the next band and repeat.
4. Press **MENU** twice to return.



Tone/Code Search selects whether the scanner searches for CTCSS/DCS tones, P25 NAC codes, or no codes in Search and Close Call modes. The scanner ignores this setting in AM, WFM, and FMB bands.

1. Scroll to 'Tone/Code Search' and press **E/** .
2. Scroll to 1 of 3 options and press **E/** 
 - Off** - the scanner does not search and display any tones.
 - CTCSS/DCS Search** - the scanner searches and displays only CTCSS/DCS tones.
 - P25 NAC Search** - the scanner searches and displays only NAC tones.



Repeater Find this feature sets whether the scanner tries to tune to a repeater output frequency when it detects a transmission on a repeater input frequency in Search and Close Call modes. Since you can normally only hear one side of a conversation when you listen to an input frequency transmission, turning this feature on can let you hear both sides of the conversation on the output frequency. If the scanner detects the transmission on the output frequency, it beeps and 'Repeater Found' appears, and it remains on the output frequency until transmissions end. The default setting is Off.

1. Scroll to 'Repeater Find' and press **E/** .
2. Scroll to On or Off and press **E/**  to save and exit.



Max Auto Store this value sets how many hits the scanner will automatically store when it is in either Search and Store or Close Call Auto Store mode. When the scanner reaches the maximum number of hits you set, it stops the auto-store operation.

1. Scroll to 'Max Auto Store' and press **E/** .
2. Enter a value from **1-256** then press **E/**  to save and exit.

Set Delay Time this setting determines how long the scanner waits after a transmission ends before resuming Quick Search and Close Call Search operations. A negative delay will force a resume after that number of seconds. The default setting is 2 seconds.



1. Scroll to 'Set Delay Time' and press **E/** .
2. Scroll to the desired delay time (-10, -5, -2, 0, 1, 2, 5, 10, or 30 secs.) and press **E/**  to save and exit.

Set Attenuator this setting controls the attenuator for Quick Search, Close Call, and Band Scope operations. Turn on this setting if you are near other strong signal sources to attenuate about 20dB. Attenuation sometimes helps to reduce interference and desensitization that strong signals create. The default setting is Off.



1. Scroll to 'Set Attenuator' and press **E/** .
2. Scroll to On or Off and press **E/**  to save and exit.

Note: You can also toggle attenuation for search/close call mode by pressing  then 7(ATT).



Set Record this setting enables the REC jack for Quick Search and Close Call modes. The default setting is Off.

1. Scroll to 'Set Record' and press **E/** .
2. Scroll to On or Off and press **E/**  to save and exit.

Set Audio AGC allows you to turn the AGC feature on or off for Quick Search and Close Call modes. See also Adjust Audio AGC.

1. Scroll to 'Set Audio AGC' and press **E/** .
2. Scroll to 'Analog' and press **E/**  to toggle on or off.
3. Scroll to 'Digital' and press **E/**  to toggle on or off.
4. Press **MENU** to return.

P25 Waiting Time basically gives the scanner time to determine if frequencies have digital or analog transmissions for Quick Search, Close Call, and Band Scope operations. During this time, the scanner will evaluate the received signal and, if it detects P25 data, will open squelch immediately. If P25 is not detected before the delay expires, the scanner will open squelch at the end of this delay. This is to prevent "false decode" problems (digital noise at the beginning of transmissions). The default setting is 400 ms.

1. Scroll to 'P25 Wait Time' and press **E/** .
2. Set the Wait Time from 0 to 1000 ms and press **E/** .

Note: Any analog transmissions will lose the first part of the transmission, up to the wait time you set here.

SEARCH FOR... MENU

Important! There are many options and setting in Search/Close Call Options that affect and compliment the settings for searching. Please review those first.

Edit Service Search

Set Search Key

Storing a Displayed Frequency

Service Search

Search and Store

Reviewing Locked out Frequencies

















Edit Custom Search
Custom Search

Quick Search
Searching







Auto Step Size Chart

EDITING A SERVICE SEARCH



To Edit a Service Search:

1. Press **MENU**.
2. Scroll to 'Search for...' and press **E/** .
3. Scroll to 'Edit Service' and press **E/** .
4. Scroll to the service search you want to edit and press **E/** .
5. Scroll to Set Delay Time and press **E/** .
6. Scroll to the desired delay time (-10, -5, -2, 0, 1, 2, 5, 10, or 30 secs.) and press **E/**  to save and exit.
7. A negative delay will force a resume after that number of seconds.
8. Scroll to Set Attenuator and press **E/** .
9. Scroll to On or Off and press **E/**  to save and exit.
10. Scroll to Set Record and press **E/** .
11. Scroll to On or Off and press **E/**  to save and exit.
12. Scroll to Set Audio AGC and press **E/** . See also Adjust Audio AGC.
13. Scroll to 'Analog' and press **E/**  to toggle on or off.
14. Scroll to 'Digital' and press **E/**  to toggle on or off.
15. Press **MENU** to return.
16. Scroll to P25 Waiting Time and press **E/** .
17. Set the Wait Time from 0 to 1000 ms and press **E/** .
18. Scroll to Search with Scan and press **E/** .
19. Scroll to Set Quick Key and press **E/** .

(Used for 'Search with Scan' only):

1. Scroll to 0-99 or **.No** for no quick key and press **E/**  to save and exit.
2. Scroll to Set Startup key and press **E/** .
3. Scroll to 0-9 or **.No** for no startup key and press **E/**  to save and exit.
4. Scroll to Set Number Tag and press **E/** .
5. Enter 0-999 and press **E/** .
6. Scroll to Set Lockout and press **E/** .

(Used for 'Search with Scan' only):



1. Scroll to 'Unlocked', 'Temporary L/O', or 'Lockout' and press **E/**  to save and exit.
2. Scroll to Set Hold Time (the amount of time the search will search in Scan Mode) and press **E/** .
3. Enter the hold time (**0-255** seconds) you desire and press **E/**  to save and exit. (0 will search the whole band before continuing)

4. Press **MENU** to exit.

Press **MENU** and scroll to another service search and repeat the previous steps or press **L/O** to exit.

Service Search allows you quickly select and search the scanner's preprogrammed frequencies. See Edit Service Search first.



















To start a Service Search:





























1. Press **MENU**.
2. Scroll to 'Search for...' and press **E/** .
3. At 'Service Search' press **E/** .
4. Scroll to: 'Public Safety', 'News', 'Ham Radio', 'Marine', 'Railroad', 'Air', 'CB Radio', 'FRS/GMRS', 'Racing', 'FM Broadcast', 'Military Air, or 'Special' (itinerant?) and press **E/**  to start searching.

Or, **HOLD** on any channel/frequency and press  then the number key (**1-3**) assigned to the search. Then see Searching.

Editing a Custom Search allows you to edit the 10 custom search ranges. The default custom search range names appear as Custom 1, Custom 2, and so on. See also Band Defaults.

To Edit a Custom Search:

1. Press **MENU**.
2. To Edit a Custom Search, press **MENU**.
3. Scroll to 'Search for...' and press **E/** .
4. Scroll to 'Edit Custom' and press **E/** .
5. Scroll to the custom search you want to edit (**1-10**) and press **E/** .
6. Scroll to Edit Name and press **E/** . See Entering Text.
7. Scroll to Edit Srch Limit and press **E/** .
At 'Set Lower Limit', enter the lower limit of the search range and press **E/** .
At 'Set Upper Limit', enter the upper limit of the search range and press **E/** .
8. Scroll to Set Delay Time and press **E/** .
9. Scroll to the desired delay time (-10, -5, -2, 0, 1, 2, 5, 10, or 30 secs.) and press **E/**  to save and exit. A negative delay will force a resume after that number of seconds.
10. Scroll to Set Modulation and press **E/** .
11. Scroll to Auto, AM, NFM, FM, WFM, or FMB (Broadcast) then press **E/**  to save and exit.
12. Scroll to Set Attenuator and press **E/** .
13. Scroll to On or Off then press **E/**  to save and exit.
14. Scroll to Set Step and press **E/** . See also Auto Step Sizes.
15. Scroll to Auto, 5, 6.25, 7.5, 8.33, 10, 12.5, 15, 20, 25, 50, or 100 kHz then press **E/** to save and exit.
16. Scroll to Set C-Ch only and press **E/** . (for Motorola and LTR systems).
17. Scroll to 'C-Ch Only Mode' and press **E/** .
18. Scroll to On or Off then press **E/**  to save and exit.
19. Scroll to 'Set MOT BandPlan' and press **E/** . See also Edit Band Plan.

20. Scroll to 1 of 3 options and press **E/** .
 - 800/900 Standard** - The scanner will use the regular old Motorola band plan and return to the menu.
 - 800Splinter** - The scanner will use the regular old Motorola band plan and return to the menu.
 - Custom** - Allows you to create a custom band plan for rebanded systems.
 21. At 'Select Plan' scroll to 'Band Plan 1-6' and press **E/** .
 22. At 'Set Base Freq' press **E/** .
 23. At 'Input Lower' enter the lower base frequency and press **E/** .
 24. At 'Input Upper' enter the upper base frequency and press **E/** .
 25. Scroll to 'Set Offset' and press **E/** .
 26. At 'Input Offset' enter the offset and press **E/** .
 27. At 'Select Polarity' scroll to + or - and press **E/** .
 28. Scroll to 'Set Spacing' and press **E/** .
 29. Scroll to the step size and press **E/** .
 30. Press **MENU** to return and repeat for each band plan as needed. Press **MENU** three times to return.
 31. Scroll to Set Record and press **E/** .
 32. Scroll to On or Off and press **E/**  to save and exit.
 33. Scroll to Set Audio AGC and press **E/** . See also Adjust Audio AGC.
 34. Scroll to 'Analog' and press **E/**  to toggle on or off.
 35. Scroll to 'Digital' and press **E/**  to toggle on or off.
 36. Press **MENU** to return.
 37. Scroll to P25 Waiting Time and press **E/** .
 38. Set the Wait Time from **0** to **1000** ms and press **E/** .
 39. Scroll to Search with Scan and press **E/** .
 40. Scroll to Set Quick Key and press **E/** .
- (Used for 'Search with Scan' only):
1. Scroll to 0-99 or .No for no quick key and press **E/**  to save and exit.
 2. Scroll to Set Startup key and press **E/** .
 3. Scroll to 0-9 or .No for no startup key and press **E/**  to save and exit.
 4. Scroll to Set Number Tag and press **E/** .
 5. Enter **0-999** and press **E/** .
 6. Scroll to Set Lockout and press **E/** .
 7. (Used for 'Search with Scan' only).
 8. Scroll to 'Unlocked', 'Temporary L/O', or 'Lockout' and press **E/**  to save and exit.
 9. Scroll to Set Hold Time (the amount of time the search will search in Scan Mode) and press **E/** .
 10. Enter the hold time (**0-255 seconds**) you desire and press **E/**  to save and exit. (0 will search the whole band before continuing).



11. Press **MENU** to exit.

Press **MENU** and scroll to another custom search and repeat the previous steps or press **L/O** to exit.

Custom Search

Custom Search allows you search the scanner's 10 programmed frequency ranges. See Editing a Custom Search first.

To start a Custom Search:





1. Press **MENU**.
2. Scroll to 'Search for...' and press **E/** .
3. Scroll to 'Custom Search' and press **E/**  to start searching.

Or, Hold on any channel/frequency and press  then the number key (1-3) assigned to the search. Then see Searching.

Set Search Key

The scanner has three search keys that you can assign to a special search range. The search keys are set to number keys 1, 2, and 3. This allows you to start a service, custom, Tone-Out, or Band Scope search without having to go into the menus.

To program a Search Key:

1. Press **MENU**.
2. Scroll to 'Search for...' and press **E/** .
3. Scroll to 'Set Search Key' and press **E/** .
4. At 'Select Key No.' scroll to 'Search Key 1-3' and press **E/** .
5. Scroll to any service search, custom search, 'Tone-Out', or 'Band Scope' and press **E/** .
6. Repeat for any other search keys you want to program. Press **L/O** to exit.

The default settings for the **BCD996P2** are:

SRCH 1: Custom 1

SRCH 2: Public Safety

SRCH 3: Band Scope Mode



Auto Search and Store



Auto Search and Store allows you search and store frequencies from enabled custom search ranges or a service search range into a conventional system, or new talkgroup IDs into a trunked system. To store frequencies or talkgroup IDs you find during Auto Store, you must first select a system where the frequencies or talkgroup IDs will be stored. You will not hear any audio in this mode.

See Max Auto Store first to set the maximum number of hits the scanner will store.

Tip: Before you start an auto search and store, run the custom search(es) or service search first to lock out the birdies, data, noise, etc. This will prevent the scanner from stopping on them and doing a memory check each time it passes.

To Auto Store Conventional Frequencies:





1. Press **MENU**.
2. Scroll to 'Search for...' and press **E/** .
3. Scroll to 'Search and Store' and press **E/** .

4. At 'Select Store Sys' scroll to the conventional system you want to store the frequencies in and press **E/** .
5. At 'Select Range' scroll to the 'service search' or to 'custom search' to select where to search from and press **E/** .

Notes: The quick key for the system must be turned on (if one is assigned to the system) and not locked out to select the system to store frequencies in otherwise you will see 'Nothing to Scan'. If no systems are programmed 'No System Stored' appears.

When you have selected a service search or custom search range(s), the scanner looks for active frequencies within the range(s) and 'Search and Store' appears on the display's lower line and the system name and search range name(s) appear on the display's upper line. When the scanner finds an active transmission, it checks to see if the frequency has already been stored in the system ('Memory Check' in the display). If the frequency has already been stored, the scanner continues to search. If the frequency has not been stored, it stores the frequency into a (created) group named 'Found Channels', then resumes searching. 'Limit Reached' will appear in the display when the Max Auto Store value is reached.

To Auto Store IDs:

1. Press **MENU**.
2. Scroll to 'Search for...' and press **E/** .
3. Scroll to 'Search and Store' and press **E/** .
4. At 'Select Store Sys' scroll to the trunked system you want to store the IDs in and press **E/** .
5. At 'Select Site' scroll to the site you want to store the IDs in and press **E/** .



Notes: The quick key for the system must be turned on (if one is assigned to the site) and not locked out to select the system to store IDs in otherwise you will see 'Nothing to Scan'. If no systems are programmed, 'No System Stored' appears. Search and store does not work if an EDACS SCAT system is selected.

'ID Search and Store' appears on the display's lower line and the system name appears on the display's upper line. When the scanner finds an active transmission, it checks to see if the ID has already been stored in the system ('Memory Check' in the display). If the ID has already been stored, the scanner continues to search. If the ID has not been stored, it stores the ID into a (created) group named 'Found Channels', then resumes searching. 'Limit Reached' will appear in the display when the Max Auto Store value is reached.

Quick Search

Quick Search allows you search from the currently-tuned frequency if you are scanning, or enter a frequency to start searching from. Quick Search will search all the way up to 1300 MHz or all the way down to 25 MHz then start over.

Note: As there is no 'Step' setting in 'Search and Close Call Options', you will have to set the step in 'Band Defaults'.

1. To start searching at the current frequency in scan mode quickly press Hold to hold on the frequency.
2. Press  then **SCAN/SEARCH**.
3. At 'Quick Search?' press . Then see Searching.
4. Press **SCAN/SEARCH** to exit.
5. To start searching at a specific frequency while scanning or searching, press **HOLD** to hold on any channel or frequency.

6. Enter the new frequency you wish to start at then press **HOLD** to set the new starting frequency.
7. Press **HOLD** again to release hold mode and start searching. Then see Searching.
8. Press **SCAN/SEARCH** to exit.

Searching (only, not Search with Scan)

1. To start a search see Quick Search, Service Search, or Custom Search.
2. To toggle search bands on or off for custom searches press the number key of the custom search.
3. To access (1) search using the programmed search keys press **☐** then the search key **1(srch 1)**, **2(srch 2)**, or **3(srch 3)** to start searching.
4. To change search direction or continue searching turn the scroll control back or forward.
5. To hold on a frequency press **HOLD**. Press **HOLD** to resume.
6. To step through the frequencies turn the scroll control.
7. Press **HOLD** to resume.
8. To store a frequency press **HOLD** to hold on the frequency.
9. Then see Storing a Displayed Frequency.
10. To toggle the lockout status of a frequency press **L/O**.
11. To turn Intermediate Frequency Exchange on or off press **HOLD** to hold on the frequency then press **☐** then **4(IFX)**. Press Hold to resume.
12. To turn the attenuator on or off for each custom or service search press **☐** then press **7(ATT)**. (Press and hold **7(ATT)** for global attenuation).
13. To check for a repeater frequency press **HOLD** to hold on the frequency.
14. Press **☐** then press and hold **8(REV)**. Press Hold to resume.
15. To toggle modulation for a search press **HOLD** to hold on each search.
16. Press **7(ATT)** then **9(MOD)**. Press **HOLD** to resume.
17. To toggle Close Call modes press **SQ**().
18. To review and unlock search frequencies press **☐** then **L/O**.
19. To unlock all frequencies of all search/close call ranges Hold on any search and press and hold **L/O**.

Storing a Displayed Frequency (while searching)

To store a displayed frequency into an existing group:

1. Quickly press **E/☐**.
2. At 'Quick Freq Save?' press **.No**.
3. At 'Select System' scroll to the system where you want to store the frequency and press **E/☐**.
4. At 'Select Group' scroll to the group where you want to store the frequency and press **E/☐**.

After storing the frequency, you will be at the 'Edit Channel' menu to complete the settings for the new channel.

If you don't want to edit the channel settings or are done editing the channel, press **L/O** to return to searching.

To store a displayed frequency into a 'Quick Save Group' in a 'Quick Save System', quickly press **E/** .

At 'Quick Freq Save?' press **E/** .

The scanner will save the frequency into a (created) group called 'Qck Save Grp' in a (created) system called 'Qck Save Cnv Sys' (with no quick key assigned) and you will be at the 'Edit Channel' menu to complete the settings for the new channel. Then see Edit Group Options and Edit Conventional Systems Options to customize the group and system.

If you don't want to edit the channel settings or are done editing the channel, press **L/O** to return to searching.

Note: If the frequency is already stored in the group, 'Frequency Exists' Accept? (Y/N) appears. Press .No to return to searching (or search hold) or E/  to go to the 'Edit Channel' menu.



CLOSE CALL MENU

Your scanner's Close Call feature lets you set the scanner so it detects, alerts you to, and displays the frequency of a nearby strong radio transmission. You can set the scanner so the Close Call feature checks for a Close Call hit every 2 seconds in the background while you are scanning or searching or use Close Call only mode. It will automatically display the frequency; no key press is required. 'Close Call Do-Not-Disturb' will only check for close call signals when you are not receiving transmissions. You can also set the frequency band(s) where you want the scanner to look for transmissions. When the scanner detects a Close Call hit, it alerts you according to the override and alert settings. You can also set the scanner to Auto Store Close Call hits.

'Hits with Scan' is a special system that automatically stores the last 10 Close Call hits until you cycle power. The system 'Close Call' is created when you run a Close Call Auto Store.

The Close Call feature works well for locating the source of strong local transmissions such as mobile and handheld two-way radios in areas with no other strong transmission sources. Several factors affect Close Call performance. Performance is increased with higher transmit power, receive antenna tuned to the target band, and a low background RF level. Other than the antenna, you have no control over these factors, but they explain why performance might vary by both location and time. The Close Call feature works better with some types of transmissions than others. It might not correctly display frequency information for transmitters using a highly directional antenna (such as an amateur radio beam antenna) or if there are many transmitters operating at the same time in the same area.

To Edit Close Call Options:

1. Press **MENU**.
2. Scroll to 'Close Call' and press **E/** .
3. Scroll to the options below and press **E/** .
4. Press **SCAN/SEARCH** to return to scanning when done with editing.

Important! There are many options and settings in Search/Close Call Options that affect and compliment the settings for Close Call. Please review those first.

Notes: The items below do not follow the radio's menu order because they should be in the following order to properly setup and use the Close Call features. As there is no 'Step' setting in 'Search and Close Call Options', you will have to set the step in 'Band Defaults'.

Set CC Bands

Set CC Override

Close Call Only

**Using Close Call
Modes**



Set CC Alert

Set CC Mode

CC Auto Store

**Managing Close Call
Hits
Hits with Scan**

Set CC Bands allows you select the Close Call bands to be searched or auto stored.

1. Scroll to 'Set CC Bands' and press **E/** .
2. Scroll to each band and press **E/**  to toggle on or off.
3. Press **MENU** to return.

VHF Low 1 - Band 1 - 25-54MHz

VHF Low 2 - Band 2 - 54-108 MHz

Air Band-Band 3 - 108-137 MHz









VHF High1 - Band 4 - 137-225 MHz

VHF High2 - Band 5 - 225-320 MHz



UHF-Band 6 - 320-512 MHz

800MHz+-Band 7 - 758-960, 1240-1300 MHz

Set CC Alert allows you to set an alert tone, alert light, and controls the pause for Close Call when you receive a hit.

1. Scroll to 'Set CC Alert' and press **E/** .
2. Scroll to 'Set Alert Tone' and press **E/** .
3. At 'Set Tone' scroll to the alert (Alert 1-9 or Off) and press **E/** .
4. At 'Set Level' scroll to 'Level 1-15 or Auto' (the scanner sets the alert beep to the master volume level) and press **E/** .
5. Scroll to 'Set Alert Light' and press **E/** .
6. Scroll to Off, Blue, Red, Magenta, Green, Cyan, Yellow, or White and press **E/** .
7. At 'Set Pattern' scroll to On, Slow Blink, or Fast Blink and press **E/** .
8. Press **MENU** to return.
9. Scroll to 'Set CC Pause' and press **E/** .
10. Scroll to the number of seconds (3, 5, 10, 15, 30, 45, 60, secs. or Infinite) you want the scanner to pause on the CC hit and press **E/** .

Set CC Override allows you select how the Close Call feature works while scanning or searching. This setting has no effect in 'Close Call Only' mode.

1. Scroll to 'Set CC Override' press **E/** .
2. Scroll to On or Off and press **E/**  to save and exit.

With this feature On, when the scanner detects a Close Call signal while scanning, the scanner overrides the current audio with the Close Call hit.

'Close Call' appears for the length of time set in Close Call Pause (or until the signal is lost if longer).

With this feature Off, when the scanner detects a Close Call signal while scanning, the scanner does not override the current audio.

'Close Call' appears for the length of time set in Close Call Pause. (only if it's still there).

Set Close Call Mode selects the Close Call mode when scanning or searching. You can also toggle these modes by pressing **SQ** in scan mode.

1. Scroll to 'Set CC Mode' and press **E/**.
2. Scroll to 1 of 3 modes and press **E/** to save and exit.

Off - Close Call is turned off.

CC DND - Close Call checks for frequencies every two seconds between transmissions.

PRI - Close Call checks for frequencies every two seconds.

Close Call Only this setting puts the scanner in Close Call Only mode. You can also do this by pressing and holding **SQ** in scan mode. You will see activity in the 7 bands in the display. Bands with a * (asterisk) under them are turned off.

1. Scroll to 'Close Call Only' and press **E/**.
2. Press **SCAN/SEARCH** to exit.

CLOSE CALL AUTO STORE

Allows you to automatically store Close Call hits into channels. If you turn this feature on, the scanner mutes, starts Close Call Only mode, and stores any Close Call hits from the bands selected in 'Set CC Bands' up to the maximum you specified in the 'Max Auto Store' setting. The scanner looks for active frequencies within the range(s) and 'Search and Store' appears in the display. When the scanner finds an active transmission, it checks to see if the frequency has already been stored in the system. If the frequency has already been stored, the scanner continues to search. If the frequency has not been stored, it stores the frequency into a (created) system called 'Close Call' and a (created) group named 'Found Channels' then resumes searching. This new system and group have the same options as any conventional system/group and can be edited the same way.

1. Scroll to 'CC Auto Store' and press **E/**.
You will see activity in the enabled bands in the display. Bands with a * (asterisk) under them are turned off.
'Limit Reached' will appear in the display when the 'Max Auto Store' value is reached.
2. Press **SCAN/SEARCH** to exit or **HOLD** to go to 'Close Call Only' mode.

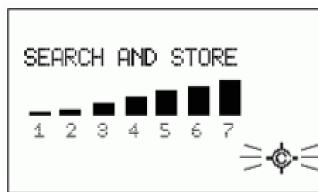

Close Call Auto Store

USING CLOSE CALL MODES

To Start Close Call Only Mode, press and hold **SQ**.

To Use Close Call while Scanning or Searching, press **SQ** to toggle Close Call Priority, Close Call DND, or Off.

MANAGING CLOSE CALL HITS

In Close Call Only Mode

When the scanner detects a Close Call signal, 'Close Call' appears for the length of time set in Close Call Pause (or until the signal is lost if longer).

The band number will blink under the band that the hit was found in.

The frequency is displayed for the (+) delay time set in Search/Close Call Options (even if it's gone).

To hold on a CC hit press **HOLD**. Press **HOLD** again to resume. See Close Call Hold Mode.

To store a frequency press **E/** then see Storing a Displayed Frequency.

To cancel a CC hit turn the scroll control.

To toggle CC bands off or on press the number key for each band.

To toggle the lock out status of a frequency press **L/O**.

To view the last CC hit press **HOLD**. Press **HOLD** again to resume.

To toggle the attenuation on or off (for all bands) press then **7(ATT)**.

To toggle the modulation (for all bands) press then **9(MOD)**.

To exit CC only press **SQ**.

While Scanning or Searching with Close Call Override set to On, when the scanner detects a Close Call signal, the scanner overrides the current audio and goes to the Close Call hit.

'Close Call' appears for the length of time set in Close Call Pause (or until the signal is lost if longer). If you do not press 'HOLD', the scanner will return to scanning after 'pause' times out.

The signal is audible and displayed for the (+) delay time set in Search/Close Call Options (even if it's gone).

Quickly press **HOLD** to stay on the frequency. Press **HOLD** again to resume.

While Scanning or Searching with Close Call Override set to Off, when the scanner detects a Close Call signal, the scanner does not override the current audio.

'CC Found!' and 'Press Func Key' appear for the length of time set in Close Call Pause. If you do not press 'Func', the scanner will return to scanning after 'pause' times out.

Press to listen to and display the frequency for the (+) delay time set in Search/Close Call Options (only if it's still there).

Quickly press **HOLD** to stay on the frequency. Press **HOLD** again to resume.

IN CLOSE CALL HOLD MODE

To store a frequency press **E/** then see Storing a Displayed Frequency.

To toggle the lock out status of a frequency press **L/O**.



To start a 'Quick Search' at the current frequency turn the scroll control then press **HOLD**.

To turn Intermediate Frequency Exchange on or off press then **4(IFX)**.

To check for a repeater frequency press then press and hold **8(REV)**.



Hits with Scan

This is a special system that automatically stores the last 10 close call hits and allows you to scan them. Accessible only in the 'Close Call' menu, the system has to be unlocked to view while scanning (default is 'locked out'). The scanner deletes the frequencies in this system when you turn the power off. If you want to save any of these frequencies permanently, you need to store them using Storing a Displayed Frequency when scanning this system.

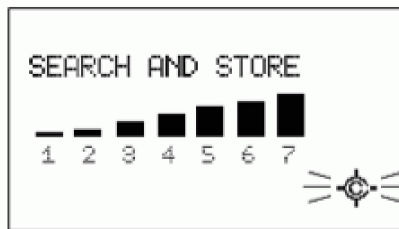





1. Press **MENU**.
2. Scroll to 'Close Call' and press **E/** .
3. Scroll to 'Hits with Scan' and press **E/** .



Close Call Auto Store

4. Scroll to the options below and press **E/** .
5. Press **SCAN/SEARCH** to return to scanning when done with editing.
6. Scroll to 'Set Quick Key' and press **E/** .
7. Scroll to the quick key number (**0-99** or **.** **No** for no quick key) you want assigned to the system and press **E/**  to save and exit.

Note: Pressing the first number of a 2-digit quick key will get you closer, 1 for 10, 2 for 20, etc. then scroll to second digit.



1. Scroll to 'Set Number Tag' and press **E/** .
2. Enter the number tag (**0-999**) you want assigned to the system and press **E/**  to save and exit.
3. Scroll to 'Set Lockout' and press **E/** .
4. Scroll to 'Unlocked', 'Temporary L/O', or 'Lockout' and press **E/**  to save and exit.
5. Scroll to 'Set Hold Time' and press **E/** .
6. Enter the hold time (**0-255** seconds) you desire and press **E/**  to save and exit.

Note: If you want to store any of the hits, set a hold time long enough to get to the E/Yes button when the frequency appears in the display.

WEATHER OPERATION MENU

Your scanner allows you to search for a local NOAA weather broadcast and set it to alert when a SAME weather alert is broadcast on a NOAA weather channel. You can also program FIPS codes into the scanner and use weather alert priority that will check the weather channel every 5 seconds for a weather alert signal.

To Edit Weather Options:

1. Press **MENU**.
2. Scroll to 'WX Operation' and press **E/** .
3. Scroll to the settings and options below and press **E/** .
4. Press **SCAN/SEARCH** to return to scanning when done with editing.







Weather Scan	Program SAME	Set Attenuator	Set Audio AGC
Weather Alert Priority	Set Delay Time	Set Record	Weather Alert

Weather Scan The scanner starts scanning the preprogrammed weather frequencies and stops on the first good signal. If the signal is lost, the scanner resumes searching for another weather transmission.

Note: You can also turn on weather scan by pressing and holding the WX button in scan or search modes.

1. Scroll to 'Weather Scan' press **E/** .
2. Press **SCAN/SEARCH** to exit.



In Weather Scan Mode:

1. To search for another weather channel turn the scroll control.
2. To start Weather Alert press  then **WX**.
3. Scroll to 'Alert Only', 'SAME 1-5', or 'All FIP' and press **E/** .
4. To return to Weather Scan from Weather Alert press  then **WX**.
5. To turn Intermediate Frequency Exchange on or off press  then **4(IFX)**.
6. To turn the attenuation on or off press  then **7(ATT)**.
7. To store a frequency press **E/**  then see Storing a Displayed Frequency.
8. To go to the Weather Menu in any weather mode press  then **MENU**.

Weather Alert Priority turning the weather alert priority feature on allows the scanner to check the weather channels every 5 seconds for a 1050 Hz weather alert signal and still scan or search. If you should receive an alert, you will hear a loud warbling then the weather channel audio. You will see WX in the display when Weather Alert Priority is on.

Warning! If you receive an alert it will be at **FULL** volume.

Note: You can also toggle weather alert priority in scan or search modes by pressing the WX button.

1. Scroll to 'WX Alt Priority' and press **E/** .
2. Scroll to On or Off and press **E/**  to save and exit.

Programming SAME Groups **SAME** (Specific Area Messaging System) is a system developed by the National Weather Service to reduce the number of alerts received by consumers by allowing them to hear alerts only for the county(ies) they are interested in. Each alert contains information about the type and severity of the alert, as well as the specific geographic locations affected by the alert. In addition, certain special regions and wildcard settings can be assigned. Your scanner can receive all SAME alert signals broadcast within about a 50-mile radius of where you use it.

To receive SAME alerts and broadcasts about weather occurring only in particular counties within that area, you can program up to 5 groups of 8 FIPS codes (40 codes) into the scanners memory. This lets you avoid hearing an alert that applies to an area within a 50-mile radius but not necessarily to your county or parish.

For the purpose of broadcasting weather information, the NWS has divided the United States into regions by state and county (or parish, where applicable) then assigned a 6-digit FIPS code to identify each county or parish. For example, the code for Tarrant County, Texas, is 048439. The first digit in a FIPS code identifies the county subdivision, the next two digits identify the state, and the last three digits identify the county or parish. Most FIPS codes begin with 0, which means the code represents an entire county. The NWS, however, plans to eventually subdivide some large counties. When that happens, each subdivision will be assigned a digit from 1-9, resulting in codes such as 148439, 248439, and so on.





To obtain the FIPS code for the location where you installed your scanner call the NWS toll free at 1-888-697-7263 (follow the instructions you hear).

FIPS codes are in the format nSSCCC:



n: A special subcounty designator. For an entire county, use 0.

SS: The state code.



CCC: The county code.

1. Scroll to 'Program SAME' and press **E/** .
2. At 'Select SAME' scroll to the SAME group (1-5) and press **E/** .
3. At 'Edit Name' see Entering Text to edit the name otherwise scroll to 'Edit County' and press **E/** .
4. At 'Select Code No' scroll to the spot for the code# (1-8) and press **E/** .
5. At 'Edit FIPS Code' enter the FIPS code and press **E/**  to save and exit.
6. Scroll to the next spot for the next code and repeat
7. Press **MENU** twice to return and select a different SAME group.
8. Press **MENU** to save and exit.

Set Delay Time sets the number of seconds the scanner should wait after a transmission stops before moving on to the next channel during weather scan. A negative delay will force a resume after that number of seconds. The default setting is 2 seconds.



1. Scroll to 'Set Delay Time' and press **E/** .
2. Scroll to the desired delay time (-10, -5, -2, 0, 1, 2, 5, 10, or 30 secs.) and press **E/**  to save and exit.

Set Attenuator sets the attenuator (20 dB) for weather operation. The default setting is Off.



1. Scroll to 'Set Attenuator' and press **E/** .
2. Scroll to On or Off and press **E/**  to save and exit.

Note: You can also toggle attenuation for weather scan by pressing  then 7(ATT).

Set Record enables the REC jack for weather channels and alerts. The default setting is Off.

1. Scroll to 'Set Record' and press **E/** .
2. Scroll to On or Off and press **E/**  to save and exit.

Set Audio AGC allows you to turn the AGC feature on or off. See also Adjust Audio AGC.

1. Scroll to 'Set Audio AGC' and press **E/** .
2. Scroll to 'Analog' and press **E/**  to toggle on or off.

3. Press **MENU** to return.

Weather Alert this setting turns on weather alert and determines which types of signals will trigger an alert. The scanner will mute and scan only the weather channels.

Note: *You can also turn on weather alert in scan or search modes by pressing and holding the WX button. Press WX again, then scroll to 'Alert Only', 'SAME 1-5', or 'All FIP' and press E/ [OK].*

1. Scroll to 'Weather Alert' and press E/ [OK].
2. Scroll to 1 of 7 options and press E/ [OK].

Alert Only - the scanner immediately sounds a weather alert siren when it detects the 1050 Hz weather alert tone, then opens the squelch and remains on the weather channel.

SAME 1-5 - the scanner sounds a weather alert siren for the programmed county, then opens the squelch and remains on the weather channel.

All FIPS - the scanner sounds a weather alert siren for any programmed county, then opens the squelch and remains on the weather channel.

Using Fire Tone-Out

With the tone out feature, the scanner monitors up to 10 different channels for paging tones (two-tone sequential, single tone, and group tone). See also Hardware: Tone-Out at WPA Scanner.

Tone-Out Standby Mode is used if you know and use programmed tones.

Tone-Out Search Mode is used if you don't know the tones.

Setting up Tone-Out

1. Press **MENU**. Scroll to 'Tone-Out for...' and press E/ [OK].
2. Scroll to 'Tone-Out Setup' and press E/ [OK].
3. Scroll to 'Tone-Out 1' and press E/ [OK].
4. At 'Edit Name' press E/ [OK]. See Entering Text.
5. Scroll to 'Set Frequency' press E/ [OK].
6. At 'Edit Frequency' press E/ [OK]. Enter the frequency to monitor for Tone-Out and press E/ [OK] to save and exit.
7. Scroll to 'Set Modulation' and press E/ [OK].
8. Scroll to Auto, FM, or NFM and press E/ [OK] to save and exit.
9. Scroll to 'Set Attenuator' and press E/ [OK].
10. Scroll to On or Off and press E/ [OK] to save and exit.
11. Press **MENU** to return.
12. Scroll to 'Set Tone' and press E/ [OK].















Notes: *For two-tone pages, enter the tones (in Hz) for tone A and tone B.*

For one-tone pages using short tones between 1.25 and 3.75 seconds, enter tone for tone A and 0 for B.

For long-tone pages, such as group pages of more than 3.75 seconds, enter 0 for A and the tone for B.

To search for tones, leave the tones for A and B at 0.

1. Scroll to 'Edit Tone A' and press E/ [OK].

2. Enter the tone and press **E/**  to save and exit.
3. Scroll to 'Edit Tone B' and press **E/** .
4. Enter the tone and press **E/**  to save and exit.
5. Press **MENU** to return.
6. Scroll to 'Set Delay Time' and press **E/** .
7. Scroll to one of 3 settings and press **E/**  to save and exit.
 - Off** - the scanner resumes standby as soon as the carrier drops after a page.
 - 1-30** - (seconds): the scanner resumes standby mode after the carrier drops and the selected time expires.
 - Infinite** - you must press **HOLD** after a page to resume standby mode.
8. Scroll to 'Set Alert' and press **E/** .
9. Scroll to 'Set Alert Tone' and press **E/** .
10. At 'Set Tone' scroll to the alert (Alert 1-9 or Off) and press **E/** .
11. At 'Set Level' scroll to 'Level 1-15 or Auto' (the scanner sets the alert beep to the master volume level) and press **E/** .
12. Scroll to 'Set Alert Light' and press **E/** .
13. Scroll to Off, Blue, Red, Magenta, Green, Cyan, Yellow, or White and press **E/** .
14. At 'Set Pattern' scroll to On, Slow Blink, or Fast Blink and press **E/** .
15. Press **MENU** to return.
16. Scroll to 'Set Record' and press **E/** .
17. Scroll to On or Off and press **E/**  to save and exit.
18. Press **MENU** to return then scroll to 'Tone-Out 2' and repeat to program more tones.
19. Press **MENU** to return.

Using Tone-Out Standby/Search See Setting up Tone-Out first.

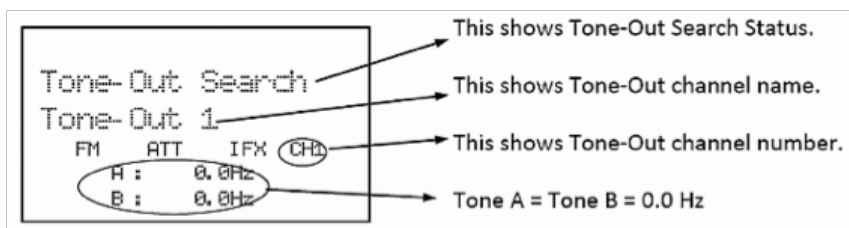
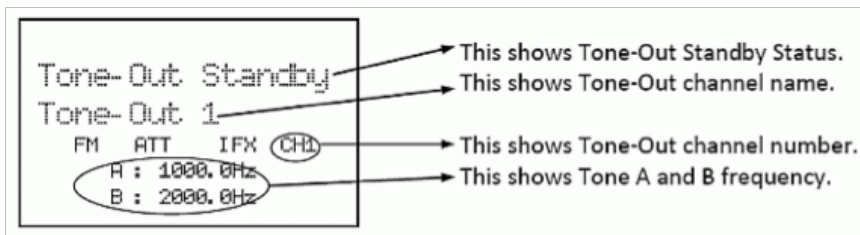

While scanning, press **⏏** then **SQ**.

Or, Press **MENU**. Scroll to 'Tone-Out for...' and press **⏏**.

Scroll to 'Tone-Out Standby' and press **⏏**.

You can also assign Tone-Out to a Search Key.

The display will show the Tone-Out name, channel number (1-10), and tone settings. Any transmission received on the frequency will not be heard but you will still see the signal strength bars.

All Tone-Outs (channels) that have the same frequency (and modulation and attenuation) as the one you select will also (and only) be monitored so you can monitor up to 10 Tone-Out channels for one frequency. In this case, the scanner displays each Tone-Out channel for two seconds. It does not scan them; Tone-Out monitors the frequency for all Tone-Out channels with the same frequency. Regardless of the current display, the scanner will alert on any received tone out that matches a stored setting (channel) for the frequency.

If you press **HOLD** while in 'Standby/Search' mode, the scanner temporarily exits and you will be able to hear any transmissions on that frequency. No alerts sound, even if a Tone-Out matches one you have programmed in hold mode. Press **HOLD** again to return to 'Standby/Search' mode.

In Tone-Out Standby Mode

1. To select another Tone-Out turn the scroll control.
2. To turn Intermediate Frequency Exchange on or off press **⏏** then **4(IFX)**.
3. To turn the attenuation on or off press **⏏** then **7(ATT)**.
4. To toggle the modulation press **⏏** then **9(MOD)**.



```
Set Found
Tone A and B?
Yes="E" / No="."
```

In Tone-Out Search Mode

1. To select another Tone-Out turn the scroll control.
2. To save found tones in Tone-Out Search mode press **E/⏏** at 'Save Found Tones?'
3. To turn Intermediate Frequency Exchange on or off press **⏏** then **4(IFX)**.
4. To turn the attenuation on or off press **⏏** then **7(ATT)**.
5. To toggle the modulation press **⏏** then **9(MOD)**.

Key-Safe Mode

This mode prevents accidental programming changes and prevents anyone from changing modes. Some keys don't work in this mode. SQ, Vol/Light, the scroll control (**⏏**), Function Mode, and Hold/Resume all still work in their primary functions. The scanner only operates in one mode; the mode the scanner was in when the radio was last turned off. So, if you turned the scanner off in Close Call mode and turn it back on in Key-Safe mode, that's the mode it will be in.

To Turn Key-Safe Mode On or Off press and hold  then turn on the scanner. The first time (only) you turn on the scanner in Key-Safe mode you will see 'Key Safe Mode On'.

In the following tables, keys with numbers in each mode refer to the legend below each chart. Keys (or Function + keys) with an 'X' don't work in that mode and will give you the 'Key-Safe' display. Keys with blank cells work as normal for each mode.

NORMAL PRESS									
	MODE								
KEYS	Scan	Service Search	Custom Search	Quick Search	Weather Scan	Close Call	Tone-Out	GPS	Band Scope
SQ	1	1	1	1	N/A	4	N/A	N/A	N/A
PRI		N/A	N/A	N/A	N/A		N/A	N/A	N/A
WX	1	1	1	1	X	1	N/A	N/A	1
GPS	X	X	X	X	X	4	X	X	X
MENU	3	X	X	X	X	4	X	X	X
L/O	1, 2	1, 2	1, 2	1, 2	N/A	1, 2		2	
1-3 (Srch 1 - Srch 3)								N/A	
4(IFX)								N/A	
5(LVL)								N/A	
6(DISP)								N/A	
7(ATT)								N/A	
8(REV)								N/A	
9(MOD)								N/A	
0								N/A	
.NO								N/A	
E/Yes	X	X	X	X	X	4	X	X	
Scan/ Search		5	5	5	X	4	X	X	X

- 1: Key-Safe only applies for press and hold for this key.
 - 2: Key-safe only allows toggle of 'Temporary Lockout' and "Unlock."
 - 3: Key-Safe only allows **MENU** for selecting system/channel number tags.
 - 4: Key-Safe only applies **after** pressing "any key."
 - 5: Key-Safe only allows Resume in Search Hold mode.
- N/A = Not applicable.

FUNCTION + PRESS									
	MODE								
KEYS	Scan	Service Search	Custom Search	Quick Search	Weather Scan	Close Call	Tone-Out	GPS	Band Scope
SQ	X	X	X	X	X	X	X	N/A	X
PRI		N/A	N/A	N/A	N/A	N/A	N/A	N/A	N/A
WX	1	1	1	1	X	1	N/A	N/A	1
GPS	X	X	X	X	X	X	X	X	X
MENU	X	X	X	X	X	X	X	X	X
L/O	1, 2	X	X	X	N/A	X	N/A	N/A	N/A
1-3 (Srch 1 - Srch 3)	3	X	X	X	X	X	X	N/A	X
4(IFX)	3	X	X	X	X	X	X	N/A	X
5(LVL)	3	N/A	N/A	N/A	N/A	N/A	N/A	N/A	N/A
6(DISP)		N/A	N/A	N/A	N/A	N/A	N/A		N/A
7(ATT)	3	X	X	X	X	X	X	N/A	X
8(REV)					N/A		N/A	N/A	N/A
9(MOD)	3	X	X	X	N/A	X	X	N/A	X
0		N/A	N/A	N/A	N/A	N/A	N/A	N/A	N/A
.NO	N/A	N/A	N/A	N/A	N/A	N/A	N/A	N/A	N/A
E/Yes	X	X	X	X	X	4	X	X	N/A
Scan/ Search	X				X	X	X	X	X

1: Key-Safe only applies for press and hold for this key.

2: Key-safe only allows toggle of "Temporary Lockout" and "Unlock."

3: Key-Safe only applies in HOLD mode.

N/A = Not applicable.

Preset Fleet Maps

There are 16 preset fleet maps programmed into your scanner to choose from. In Motorola II systems, and all the blocks have size code 0. In Type I systems, size codes are used in different blocks to denote the maximum number of users in that block. Notice that size code 12 uses 2 blocks. A Motorola Hybrid system (Type II) has 'blocks' of the system that are Type I Fleets/ Subfleets and Type II talkgroups.

Hybrid system maps are in **bold**.

Preset Map 1		Preset Map 2		Preset Map 3		Preset Map 4		Preset Map 5		Preset Map 6		Preset Map 7		Preset Map 8	
Block	Size Code	Block	Size Code	Block	Size Code	Block	Size Code	Block	Size Code	Block	Size Code	Block	Size Code	Block	Size Code
0	S-11	0	S-4	0	S-4	0	S-12	0	S-4	0	S-3	0	S-10	0	S-1
1	S-11	1	S-4	1	S-4	1	(S-12)	1	S-4	1	S-4	1	S-10	1	S-1
2	S-11	2	S-4	2	S-4	2	S-4	2	S-12	2	S-4	2	S-11	2	S-2
3	S-11	3	S-4	3	S-4	3	S-4	3	(S-12)	3	S-4	3	S-4	3	S-2
4	S-11	4	S-4	4	S-4	4	S-4	4	S-4	4	S-12	4	S-4	4	S-3
5	S-11	5	S-4	5	S-4	5	S-4	5	S-4	5	(S-12)	5	S-4	5	S-3
6	S-11	6	S-4	6	S-12	6	S-4	6	S-4	6	S-12	6	S-4	6	S-4
7	S-11	7	S-4	7	(S-12)	7	S-4	7	S-4	7	(S-12)	7	S-4	7	S-4

Preset Map 9		Preset Map 10		Preset Map 11		Preset Map 12		Preset Map 13		Preset Map 14		Preset Map 15		Preset Map 16	
Block	Size Code	Block	Size Code	Block	Size Code	Block	Size Code	Block	Size Code	Block	Size Code	Block	Size Code	Block	Size Code
0	S-4	0	S-0	0	S-4	0	S-0	0	S-3	0	S-4	0	S-4	0	S-3
1	S-4	1	S-0	1	S-0	1	S-0	1	S-3	1	S-3	1	S-4	1	S-10
2	S-0	2	S-0	2	S-0	2	S-0	2	S-11	2	S-10	2	S-4	2	S-10
3	S-0	3	S-0	3	S-0	3	S-0	3	S-4	3	S-4	3	S-11	3	S-11
4	S-0	4	S-0	4	S-0	4	S-0	4	S-4	4	S-4	4	S-11	4	S-0
5	S-0	5	S-0	5	S-0	5	S-0	5	S-0	5	S-4	5	S-0	5	S-0
6	S-0	6	S-4	6	S-0	6	S-0	6	S-0	6	S-12	6	S-12	6	S-12
7	S-0	7	S-4	7	S-0	7	S-4	7	S-0	7	(S-12)	7	(S-12)	7	(S-12)

Size Code	Fleets	Sub-Fleets	Number of Blocks	Number of Talkgroups per Block	Max IDs per Talkgroup	Max Radios per Block
S0	N/A	N/A	N/A	N/A	N/A	512
S1	128	4	1	512	16	16
S2	16	8	1	128	64	64
S3	8	8	1	64	128	128
S4	1	16	1	16	512	512
S5	64	4	1	256	32	32
S6	32	8	1	256	32	32
S7	32	4	1	128	64	64
S8	16	4	1	64	128	128
S9	8	4	1	32	256	256
S10	4	8	1	32	256	256

Size Code	Fleets	Sub-Fleets	Number of Blocks	Number of Talkgroups per Block	Max IDs per Talkgroup	Max Radios per Block
S11	2	16	1	32	256	256
S12	1	16	2	8	1024	512
S13	1	16	4	4	2048	512
S14	1	16	8	2	4096	512

You can tell which block a Motorola ID is in by its number.

Block	Lower ID#	Upper ID #
0	0000	8191
1	8192	16383
2	16384	24575
3	24576	32767
4	32768	40959
5	40960	49151
6	49152	57343
7	57344	65535

Type II Special Status Bits

Type II Motorola Smartnet systems use these status bits for special transmissions such as emergency, patches, DES/DVP scrambled transmissions, and multiselects. Motorola trunking radios directly interpret them for their special functions, thus no difference is noticed by the person with the radio. The scanner however interprets these special talkgroup status bits as different talkgroups entirely. Below is the conversion chart for these special status bits.

TT ID + #	Usage	TT ID + #	Usage
ID+0	Normal Talkgroup	ID+8	DES/DVP Encryption Talkgroup
ID+1	All Talk troupe	ID+9	DES All Talkgroup
ID+2	Emergency	ID+10	DES Emergency
ID+3	Talkgroup patch to another	ID+11	DES Talkgroup patch
ID+4	Emergency Patch	ID+12	DES Emergency Patch
ID+5	Emergency Patch	ID+13	DES Emergency multi-group
ID+6	Not Assigned	ID+14	Not Assigned
ID+7	Multi-select (initiated by Dispatcher)	ID+15	Multi-select DES TG

Therefore, if a user was transmitting a multi-select call on talkgroup 1808, the scanner would actually receive those transmissions on 1815. Some common uses of these status bits are as follows:

- When a user hits their emergency button, all conversations on the talkgroup revert to the emergency status talkgroup (ID+2) until the dispatch clears the emergency status. Therefore, if someone hit their emergency button and their radio was on talkgroup 16, all communications would switch to talkgroup 18.
- A lot of Fire and EMS departments dispatch tone-outs and alarms as Multi-select communications (ID+7). Therefore, if your fire department dispatch talkgroup is 1616, and they do dispatch tone-outs and alarms as Multi-selects, then those communications will be on talkgroup 1623.

TECHNICAL SPECIFICATIONS

Band Coverage : 31 Bands

Size: 7.2 in (W) x 5.9 in (D) x 2.2 in (H) (without antenna)
184 mm (W) x 151 mm (D) x 56 mm (H) (without antenna)

Weight: 3.5 lbs (1.59 kg.)

Operating Temperature: Nominal: - 4° F (- 20° C) to + 140° F (+ 60° C)
Close Call: + 14° F (- 10° C) to + 140° F (+ 60° C)

Storage Temperature: - 22° F (- 30° C) to + 158° F (+ 70° C)

Power Requirements: DC: 11.0V ~ 16.6V (Ext. DC power jack or DC power jack)
AC Adapter: (13.8V DC 750mA Regulated) (AD-1009)

LCD Display: 64 x 128 Full Dot Matrix LCD-with multi-color backlight

Internal Speaker: 8 ohm, 5W Max. 77mm (3.0 in.)

Certified in accordance with FCC Rules and Regulations Part 15 Sub-part C as of date of manufacture.

Weather Channels: 7 Channels

Audio Output Power:

- At 8Ω speaker Jack
2.6W nominal for FM, FMB and NFM bands
2.7W nominal for AM bands
2.5W nominal for WFM bands
- At 32Ω stereo headphone Jack
6mW nominal @FM, NFM Bands
7mW nominal @FMB, WFM Bands
10mW nominal @AM Bands

External Jacks: Antenna Jack: BNC Type
Phone Jack: 3.5mm (1/8 in.) Stereo Type
Ext.SP Jack: 3.5mm (1/8 in.) Monaural Type
REC.Out Jack: 3.5mm (1/8 in.) Stereo Type
Ext. DC Power and Orange Wire Jack: 3 pin (Center Orange Wire)
DC Power Jack: 5.5mm (1/5 in.) (Center Positive)
GPS/Remote Interface Jack: D Sub 9pin Male Type
USB Jack (front panel): 4-pin Mini USB Type

Antenna: 50 ohms (Impedance)

Sensitivity (12dB SINAD) Nominal

VHF Low Band 1

(AM)	25.005 MHz	0.4 μ V
(NFM)	40.840 MHz	0.3 μ V
(NFM)	53.980 MHz	0.3 μ V

VHF Low Band 2

(WFM)	54.050 MHz	0.6 μ V
(FM)	72.515 MHz	0.2 μ V
(FMB)	107.100 MHz	0.5 μ V

Aircraft Band

(AM)	118.800 MHz	0.3 μ V
(AM)	127.175 MHz	0.3 μ V
(AM)	135.500 MHz	0.3 μ V

VHF High Band 1

(NFM)	138.150 MHz	0.3 μ V
(NFM)	161.985 MHz	0.3 μ V
(NFM)	173.225 MHz	0.3 μ V
(WFM)	197.450 MHz	0.5 μ V
(NFM)	216.020 MHz	0.3 μ V

VHF High Band 2

(AM)	225.050 MHz	0.3 μ V
(AM)	272.950 MHz	0.3 μ V
(AM)	315.050 MHz	0.3 μ V

UHF Band

(AM)	325.050 MHz	0.3 μ V
(NFM)	406.875 MHz	0.3 μ V
(NFM)	511.9125 MHz	0.3 μ V

Public Service Band

(NFM)	758.0125 MHz	0.3 μ V
(NFM)	806.000 MHz	0.3 μ V
(NFM)	857.150 MHz	0.3 μ V
(NFM)	954.9125 MHz	0.3 μ V

1200MHz Band

(NFM)	1299.925 MHz	0.3 μ V
-------	--------------	-------------

Hum & Noise (Nominal)

VHF Low Band 1

(AM)	25.005 MHz	48 dB
------	------------	-------

(NFM)	40.840 MHz	43dB
VHF Low Band 2		
(WFM)	54.050 MHz	53 dB
(FM)	72.515 MHz	48 dB
(FMB)	107.100 MHz	59 dB
Aircraft Band		
(AM)	127.175 MHz	49 dB
VHF High Band 1		
(NFM)	161.985 MHz	41 dB
(NFM)	173.225 MHz	41 dB
(WFM)	197.450 MHz	53 dB
VHF High Band 2		
(AM)	272.950 MHz	50 dB
UHF Band		
(AM)	325.050 MHz	50 dB
(NFM)	406.874 MHz	40 dB
Public Service Band		
(NFM)	758.0125 MHz	43 dB
(NFM)	857.150 MHz	41 dB
1200MHz Band		
(NFM)	1299.925 MHz	42 dB

Close Call Sensitivity (Nominal)

(NFM)	40.8400 MHz	-62 dBm
(NFM)	161.9850 MHz	-69 dBm
(AM)	272.9500 MHz	-69 dBm
(NFM)	406.8750 MHz	-65 dBm
(NFM)	857.1500 MHz	-62 dBm
(NFM)	1299.9250 MHz	-57 dBm

FREQUENCY RANGE

Frequency Range (MHz)	Modulation	Step (kHz)	Name
25.0000-26.9600	AM	5	Petroleum Products & Broadcast Pickup
26.9650-27.4050	AM	5	CB Class D Channel
27.4100-27.9950	AM	5	Business & Forest Products
28.0000-29.6800	NFM	20	10 Meter Amateur Band
29.7000-49.9900	NFM	10	VHF Low Band

Frequency Range (MHz)	Modulation	Step (kHz)	Name
50.0000-53.9800	NFM	20	6 Meter Amateur Band
54.0000-71.9500	WFM	50	VHF TV
72.0000-75.9950	FM	5	Intersystem & Astronomy
76.0000-87.9500	WFM	50	VHF TV
88.0000-107.9000	FMB	100	FM Broadcast
108.0000-136.9916	AM	8.33	Aircraft Band
137.0000-143.9875	NFM	12.5	Military Land Mobile
144.0000-147.9950	NFM	5	2 Meter Amateur Band
148.0000-150.7875	NFM	12.5	Military Land Mobile
150.8000-161.9950	NFM	5	VHF High Band
162.0000-173.9875	NFM	12.5	Federal Government
174.0000-215.9500	WFM	50	VHF TV
216.0000-224.9800	NFM	20	1.25 Meter Amateur Band
225.0000-379.9750	AM	25	Military Aircraft Band
380.0000-399.9875	NFM	12.5	Military Land Mobile
400.0000-405.9875	NFM	12.5	Miscellaneous
406.0000-419.9875	NFM	12.5	Federal Government Land Mobile
420.0000-449.9875	NFM	12.5	70 cm Amateur Band
450.0000-469.9875	NFM	12.5	UHF Standard Band
470.0000-512.0000	NFM	12.5	UHF TV
763.0000-775.99375	NFM	6.25	Public Service Band
793.0000-805.99375	NFM	6.25	Public Service Band
806.0000-823.9875	NFM	12.5	Public Service Band
849.0125-868.9875	NFM	12.5	Public Service Band
894.0125-960.0000	NFM	12.5	Public Service Band
1240.0000-1300.0000	NFM	25	25 cm Amateur Band

SPECIAL FUNCTIONS

Band Scope Function

- Frequency Span 0.2 MHz To 500 MHz
- Frequency Step 5 kHz To 100 kHz

Two-Tone-Sequential

- 250.0-3500.0Hz , 0.1Hz Step Programmable

WX Alert

- 1050 Hz Tone System
- NWR-SAME System (Warning/Watch/Statement)

Supported Trunking Systems

- Motorola Systems: Type I, II, III (hybrid)
- EDACS Systems: FM, NFM, and SCAT
- LTR Systems
- APCO Systems: Astro Imbe, Astro 25 and P25 AMBE (HDQPSK)

Heterodyne System

1st IF:

25.000MHz – 319.995MHz, 806.000MHz – 1300.000MHz: 380.75MHz

320.000MHz – 511.995MHz, 764.000MHz – 805.995MHz: 265.55 MHz

2nd IF:

10.8 MHz

3rd IF:

450 kHz

CTCSS Tones and DCS Tone Codes - 112 codes total

CTCSS Tone Frequencies - 50 frequencies total (Hz)

67.0	69.3	71.9	74.4	77.0	79.7	82.5	85.4	88.5	91.5
94.8	97.4	100.0	103.5	107.2	110.9	114.8	118.8	123.0	127.3
131.8	136.5	141.3	146.2	151.4	156.7	159.8	162.2	165.5	167.9
171.3	173.8	177.3	179.9	183.5	186.2	189.9	192.8	196.6	199.5
203.5	206.5	210.7	218.1	225.7	229.1	233.6	241.8	250.3	254.1

DCS Tone Codes - 112 codes total

023	025	026	031	032	036	043	047
051	053	054	065	071	072	073	074
114	115	116	122	125	131	132	134
143	145	152	155	156	162	165	172
174	205	212	223	225	226	243	244
245	246	251	252	255	261	263	265
266	271	274	306	311	315	325	331
332	343	346	351	356	364	365	371
411	412	413	423	431	432	445	446
452	454	455	462	464	465	466	503
506	516	523	526	532	546	565	606
612	624	627	631	632	654	662	664
703	712	723	731	732	734	743	754
006	007	015	017	021	050	141	214

Features, specifications, and availability of optional accessories are all subject to change without notice.

WARRANTY INFORMATION

WARRANTOR: UNIDEN AMERICA CORPORATION (Uniden)

ELEMENTS OF WARRANTY: Uniden warrants, for one year, to the original retail owner, this Uniden Product to be free from defects in materials and craftsmanship with only the limitations or exclusions set out below.

WARRANTY DURATION: This warranty to the original user shall terminate and be of no further effect 12 months after the date of original retail sale.

The warranty is invalid if the Product is

- (A) damaged or not maintained as reasonable or necessary,
- (B) modified, altered, or used as part of any conversion kits, subassemblies, or any configurations not sold by Uniden,
- (C) improperly installed,
- (D) serviced or repaired by someone other than an authorized Uniden service center for a defect or malfunction covered by this warranty,
- (E) used in any conjunction with equipment or parts or as part of any system not manufactured by Uniden, or
- (F) installed or programmed by anyone other than as detailed by the Operating Guide for this product.

STATEMENT OF REMEDY: In the event that the product does not conform to this warranty at any time while this warranty is in effect, warrantor will repair the defect and return it to you without charge for parts, service, or any other cost (except shipping and handling) incurred by warrantor or its representatives in connection with the performance of this warranty. THE LIMITED WARRANTY SET FORTH ABOVE IS THE SOLE AND ENTIRE WARRANTY PERTAINING TO THE PRODUCT AND IS IN LIEU OF AND EXCLUDES ALL OTHER WARRANTIES OF ANY NATURE WHATSOEVER, WHETHER EXPRESS, IMPLIED OR ARISING BY OPERATION OF LAW, INCLUDING, BUT NOT LIMITED TO ANY IMPLIED WARRANTIES OF MERCHANTABILITY OR FITNESS FOR A PARTICULAR PURPOSE. THIS WARRANTY DOES NOT COVER OR PROVIDE FOR THE REIMBURSEMENT OR PAYMENT OF INCIDENTAL OR CONSEQUENTIAL DAMAGES. Some states do not allow this exclusion or limitation of incidental or consequential damages so the above limitation or exclusion might not apply to you.

LEGAL REMEDIES: This warranty gives you specific legal rights, and you might also have other rights which vary from state to state.

This warranty is void outside the United States of America.

PROCEDURE FOR OBTAINING PERFORMANCE OF WARRANTY: If, after following the instructions in this Operating Guide you are certain that the Product is defective, pack the Product carefully (preferably in its original packaging). Include evidence of original purchase and a note describing the defect that has caused you to return it. The Product should be shipped freight prepaid, by traceable means, or delivered, to warrantor at:

Uniden America Corporation
C/O Saddle Creek
743 Henrietta Creek Rd., Suite 100
Roanoke, Texas 76262.

(800) 620-7531, 8 a.m. to 4:30 p.m. CST, Monday through Friday